

ARKUSZ NR 1

ROK I GR 3 ROK AKADEM. 98/99
 WYDZIAŁ ARCHITEKTURY

Handwritten signature

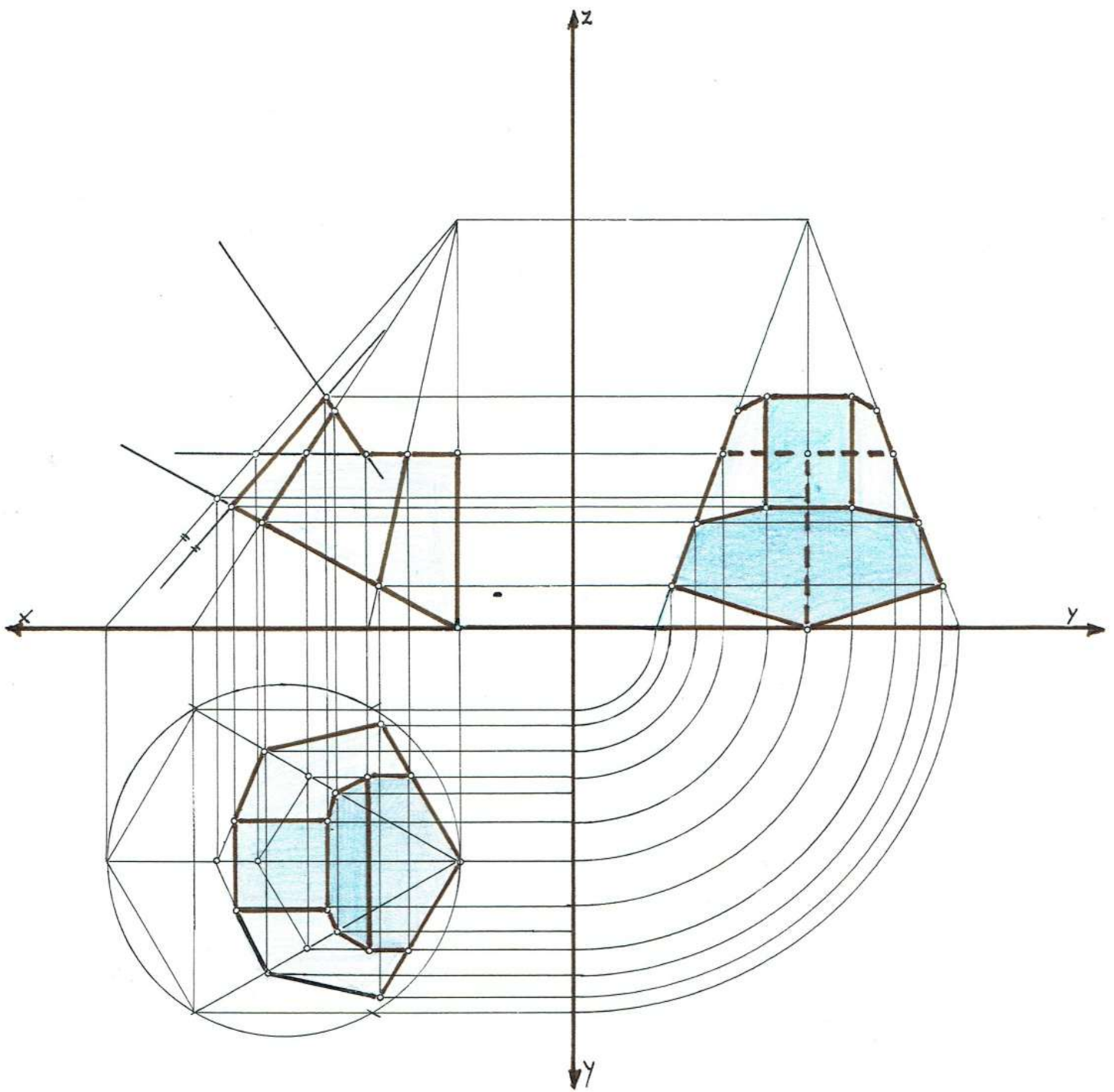

ARKUSZ NR 2

ROK I GR. 3 ROK AKADEMICKI 98/99

WYDZIAŁ ARCHITEKTURY

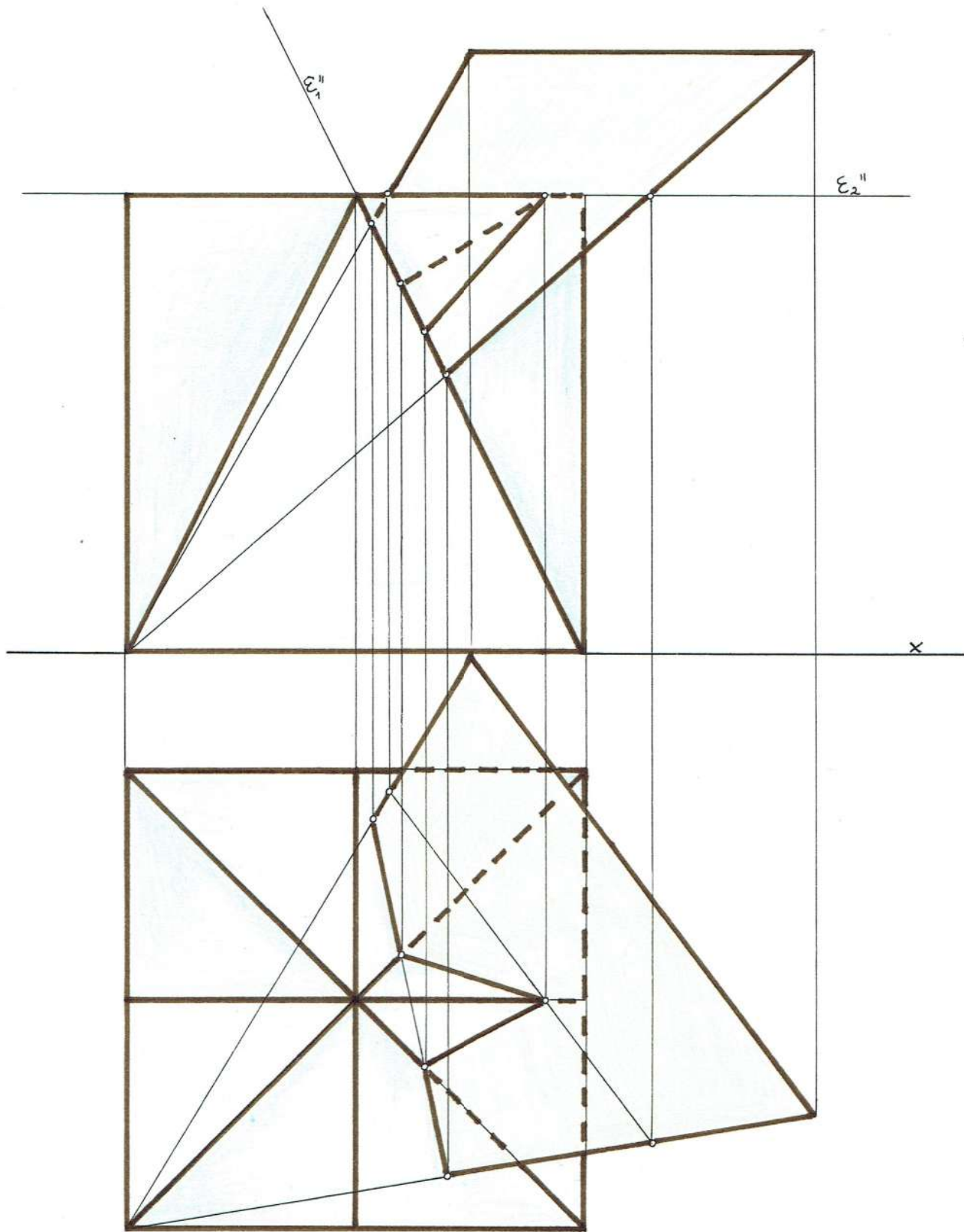

ARKUSZ NR 3

ROK I GR.3 ROK AKADEMICKI 98/99

WYDZIAŁ ARCHITEKTURY

Handwritten signature in blue ink.

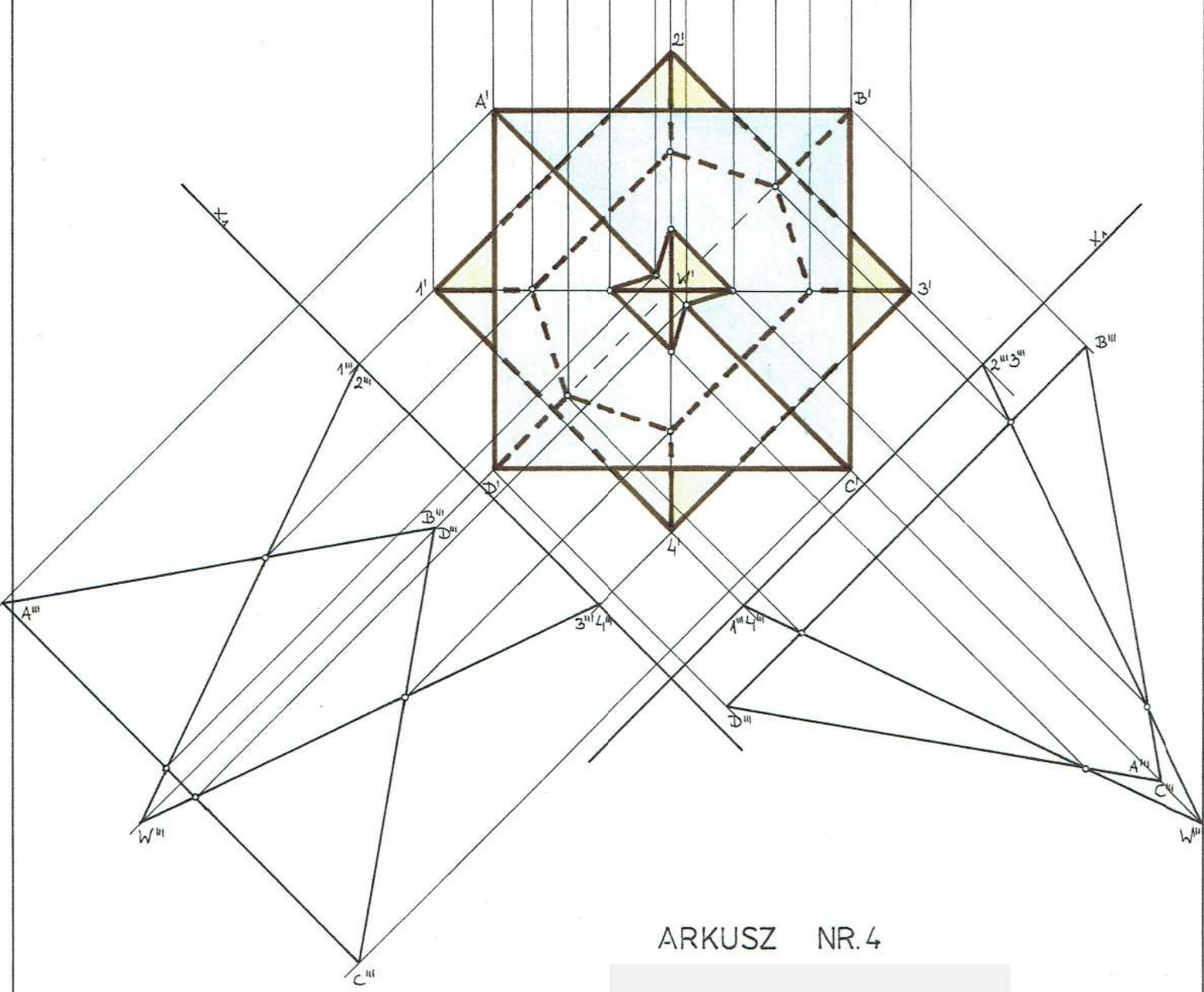
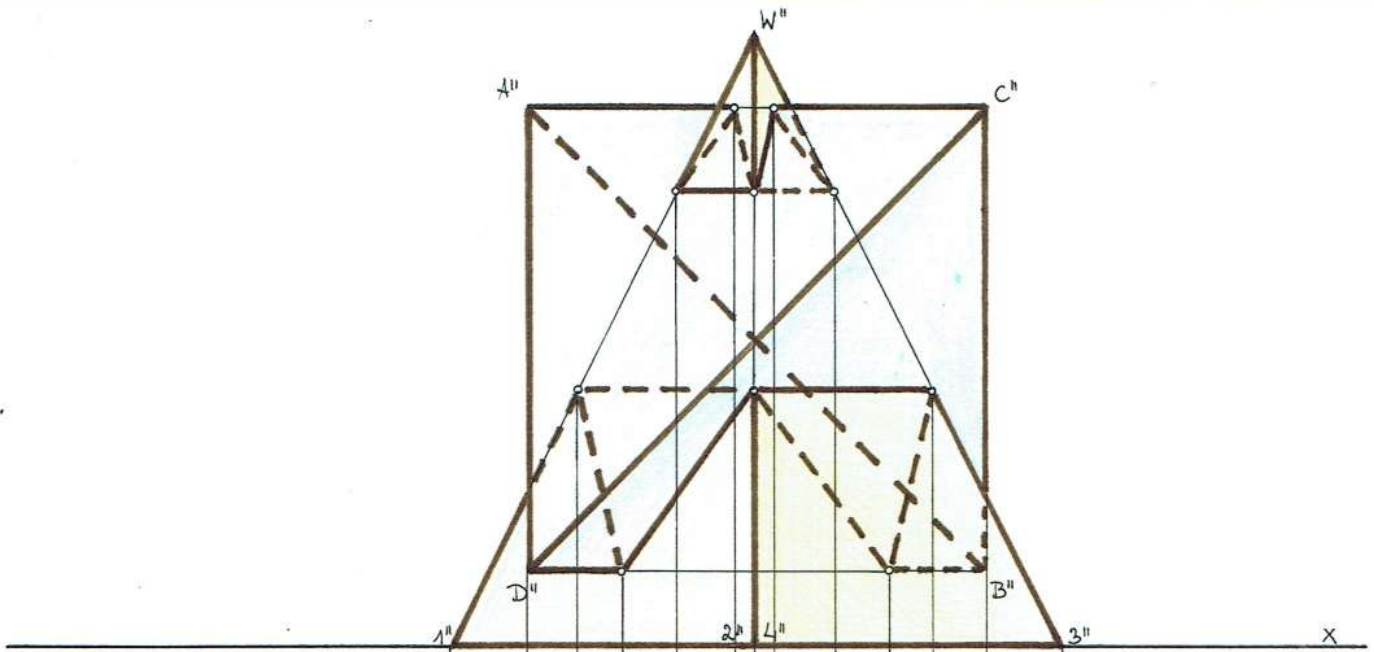

ARKUSZ NR.4

ROK I GR.3 ROK AKADEM 98/99

WYDZIAŁ ARCHITEKTURY

50/07

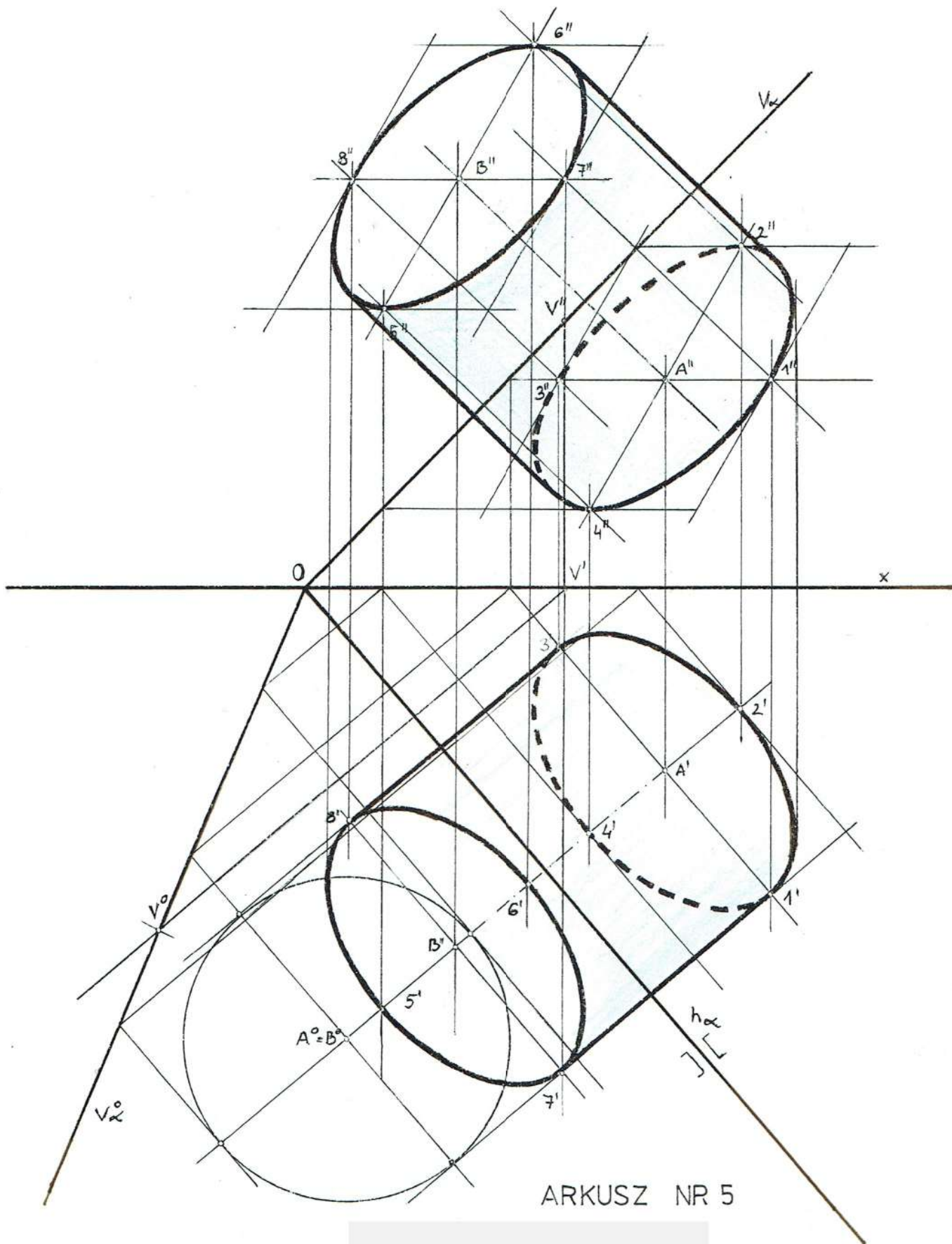

ARKUSZ NR 5

ROK I GR. 3 ROK AKADEMICKI 98/99

WYDZIAŁ ARCHITEKTURY

4.5.98

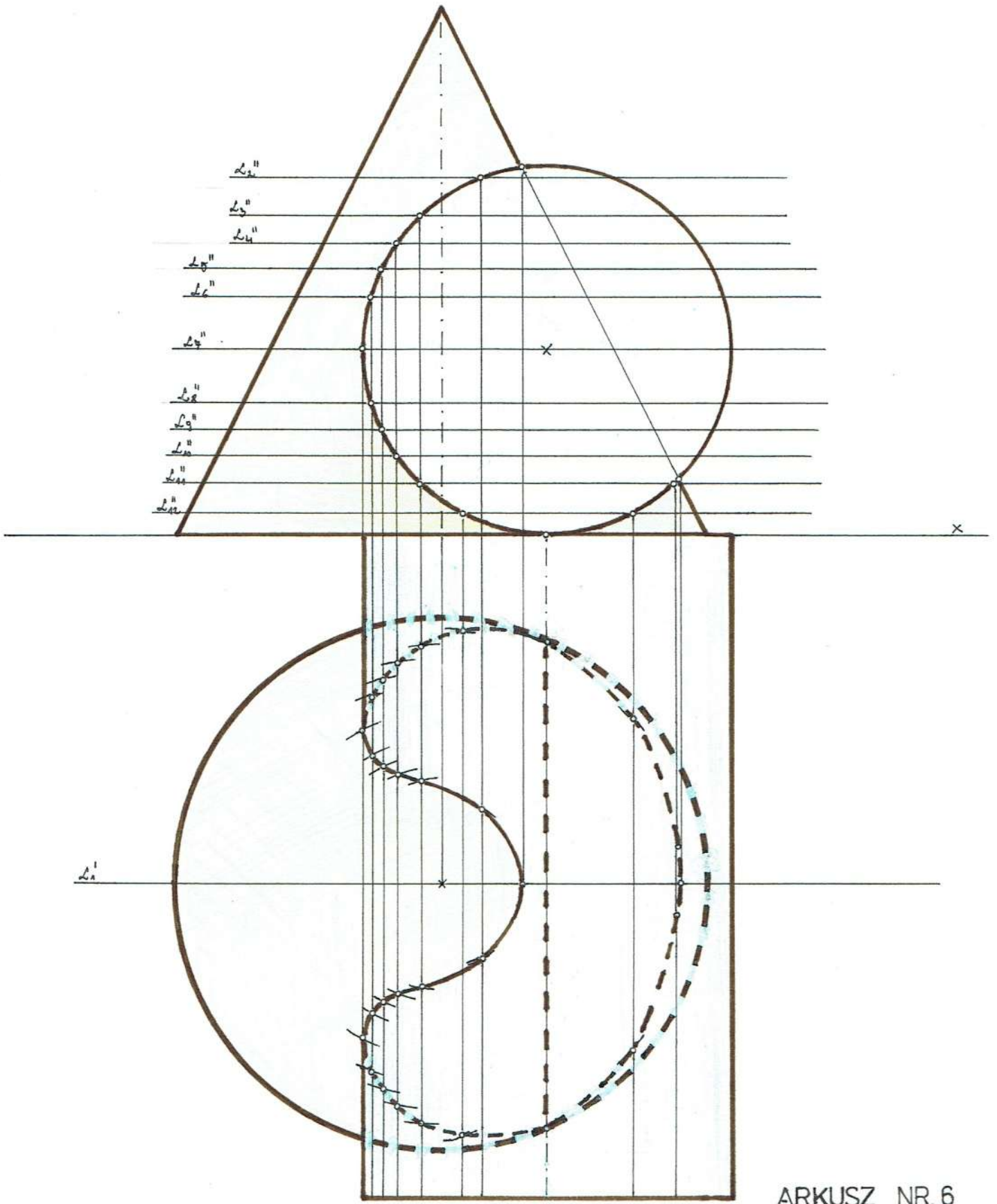

ARKUSZ NR. 6

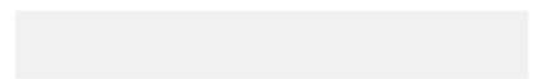

ROK I GR. 3 ROK AKADEM 98/99

5 WYDZIAŁ ARCHITEKTURY

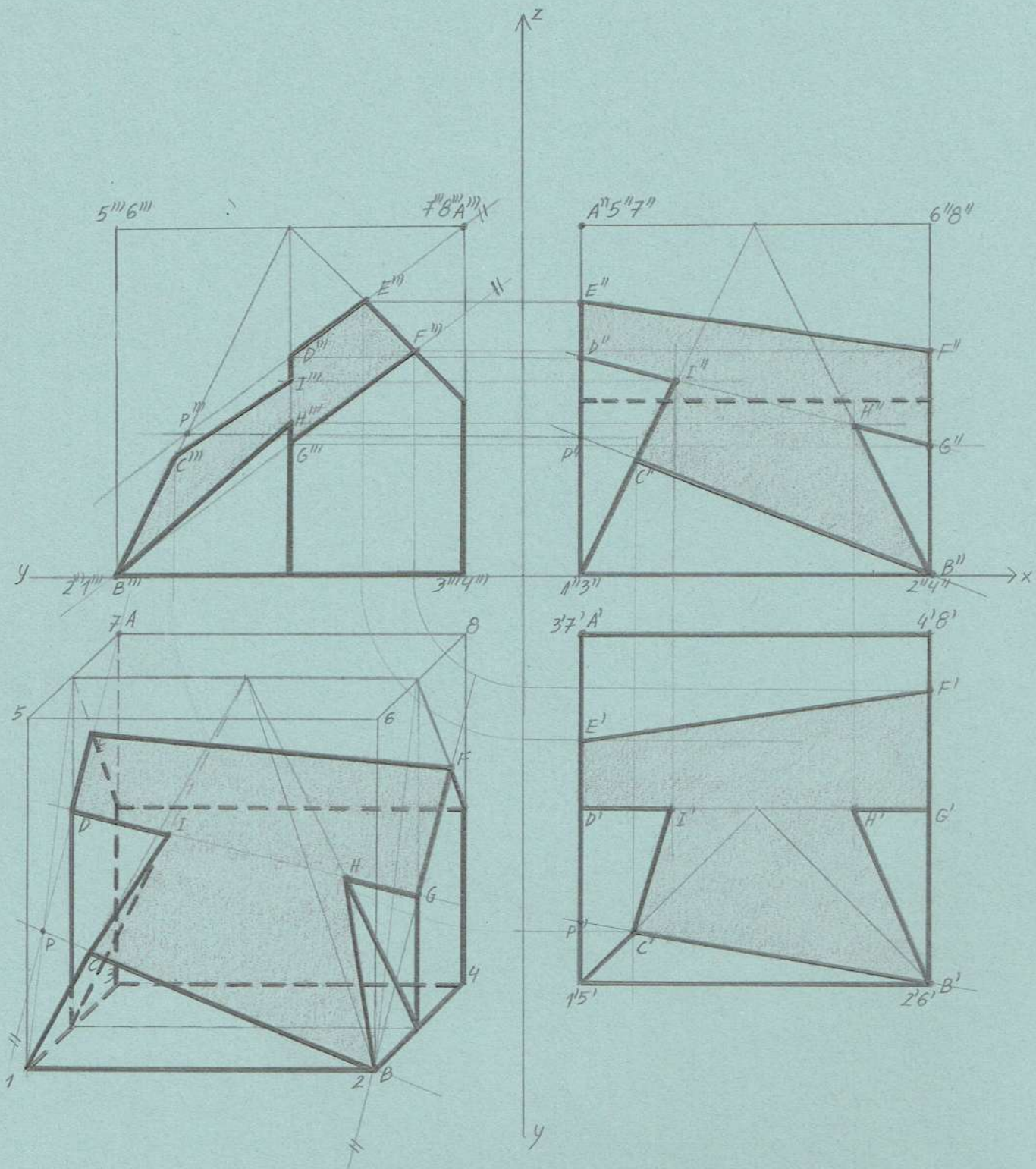

10/10/2024

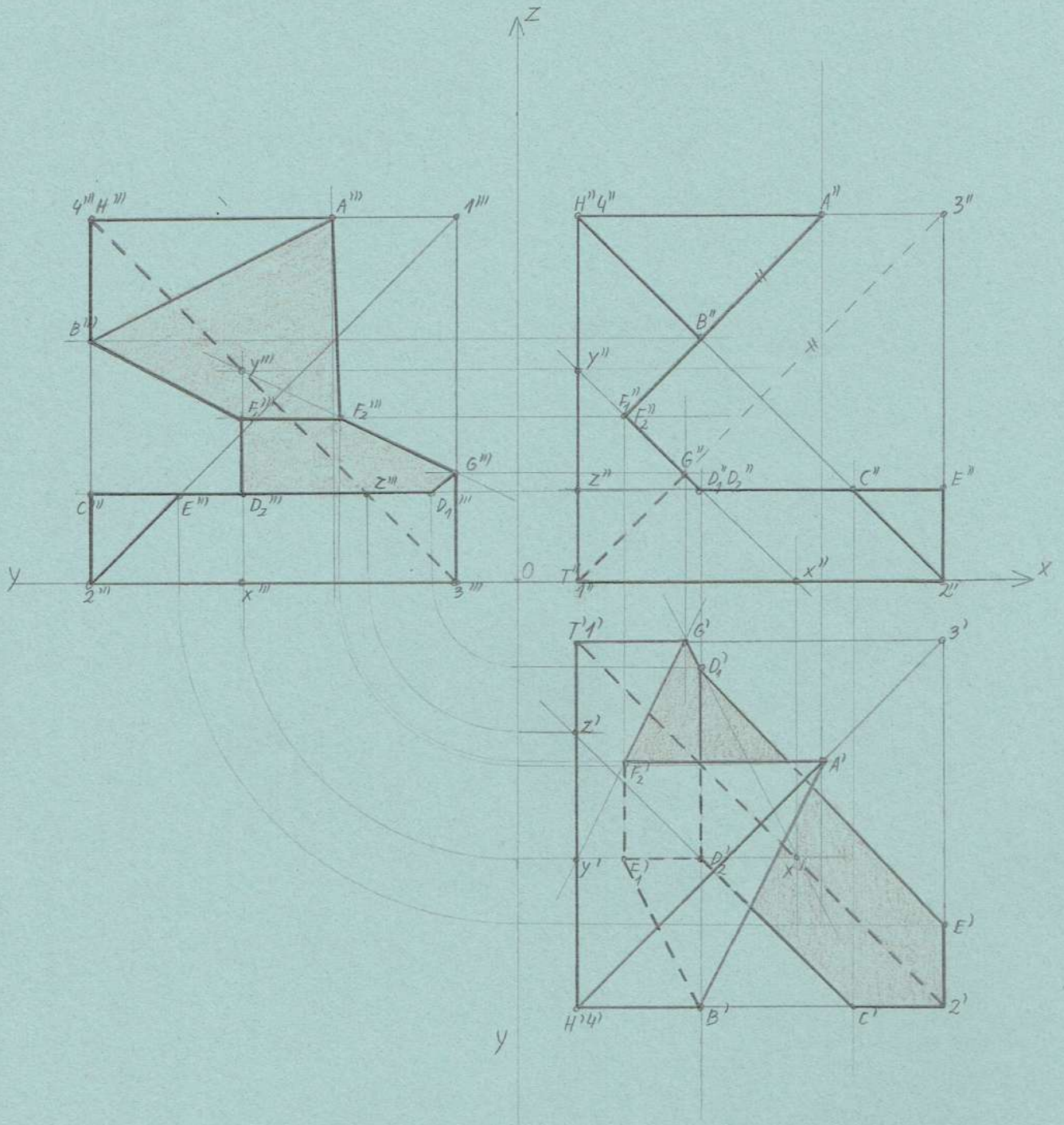

10/10/24



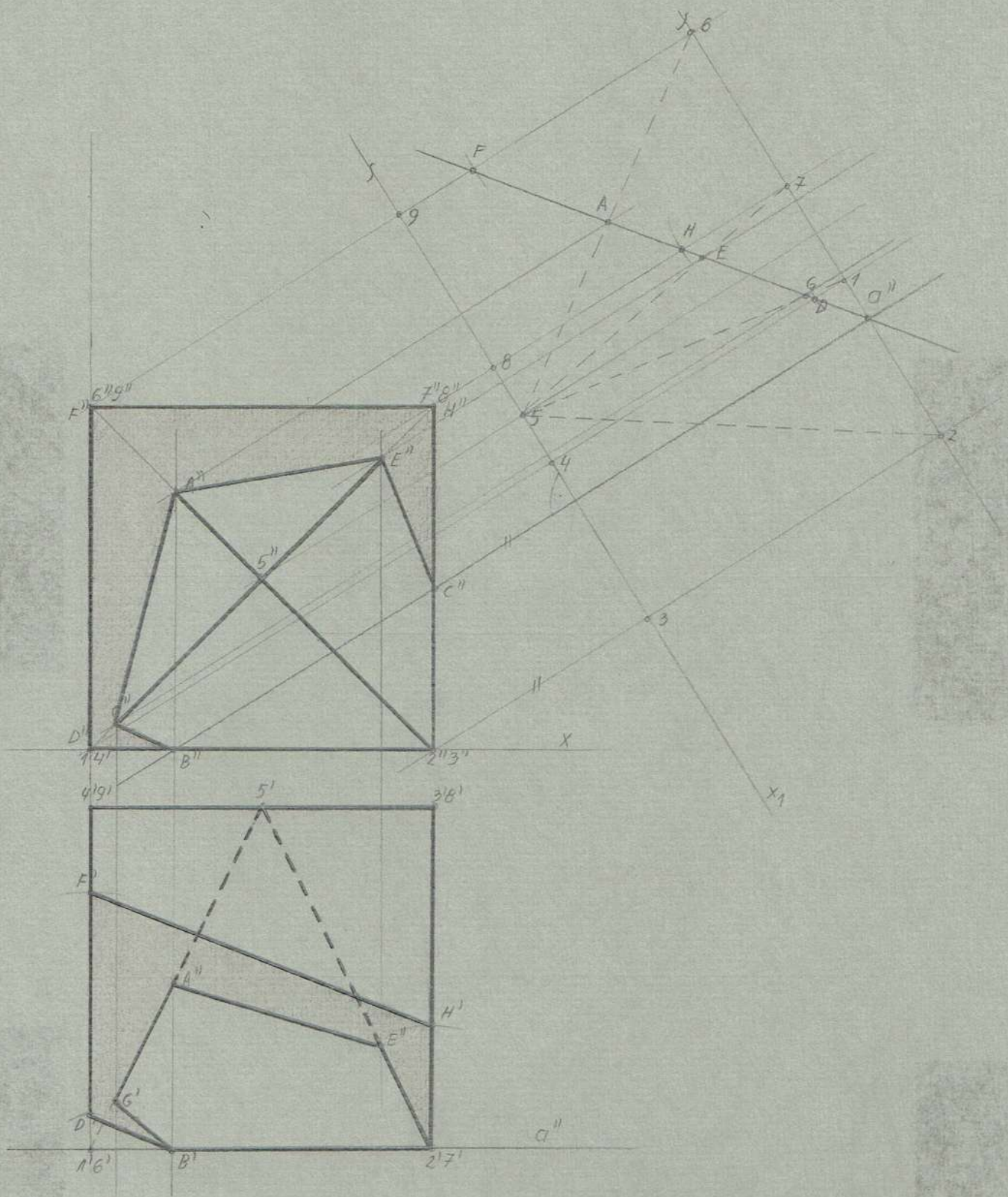

9,5/10 pec

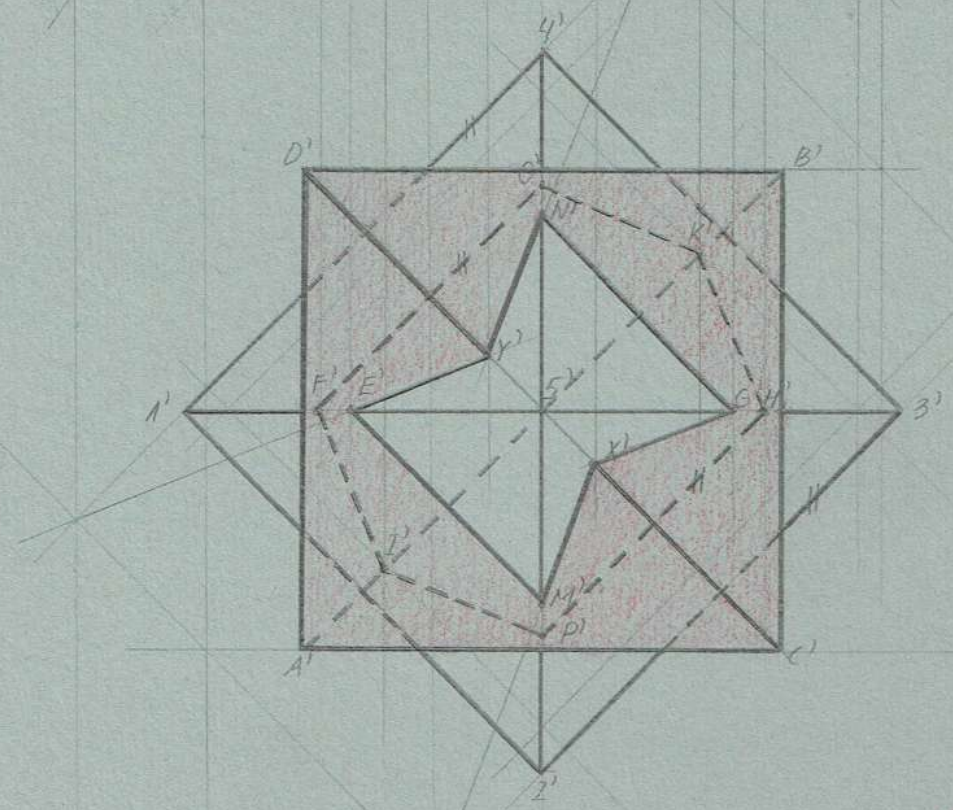
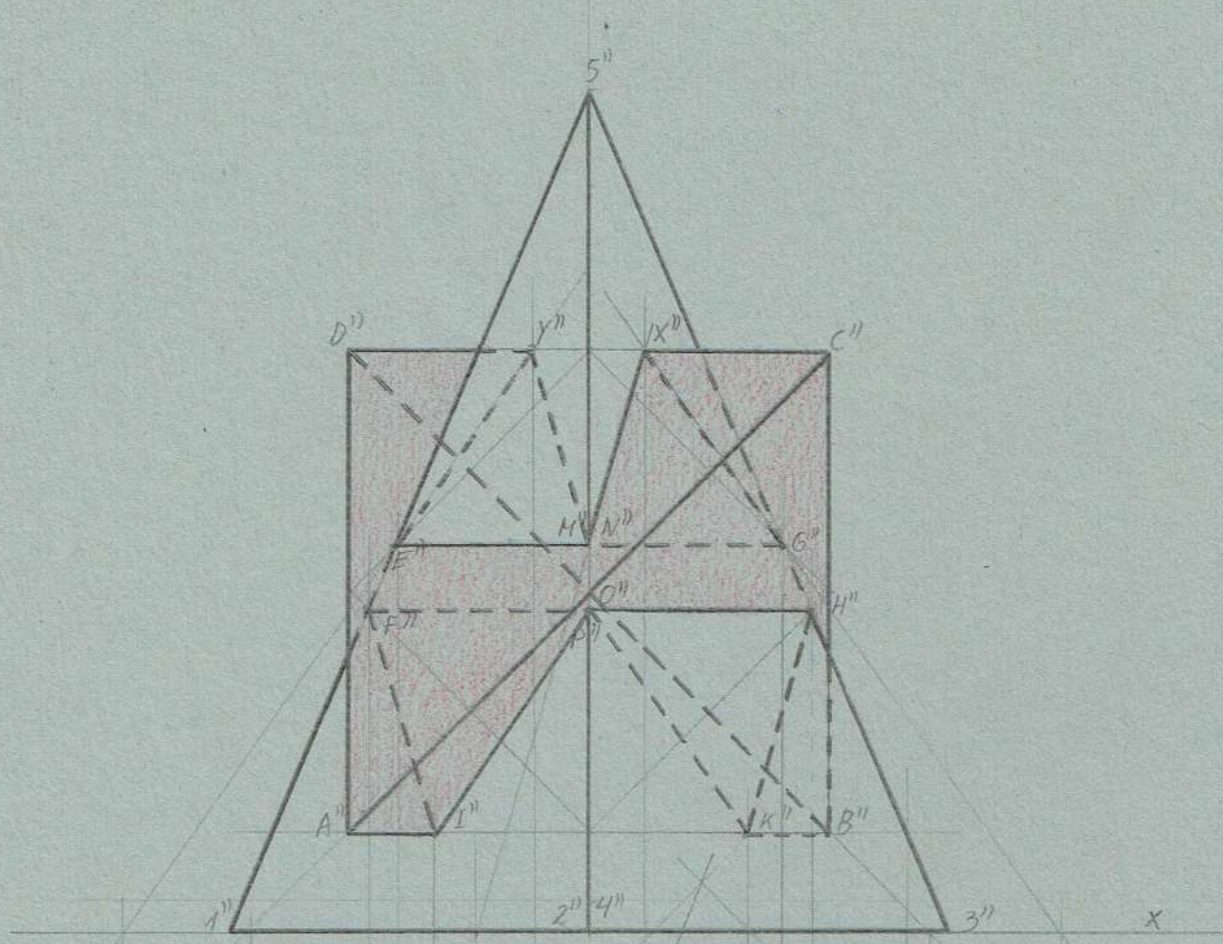

10/10/17



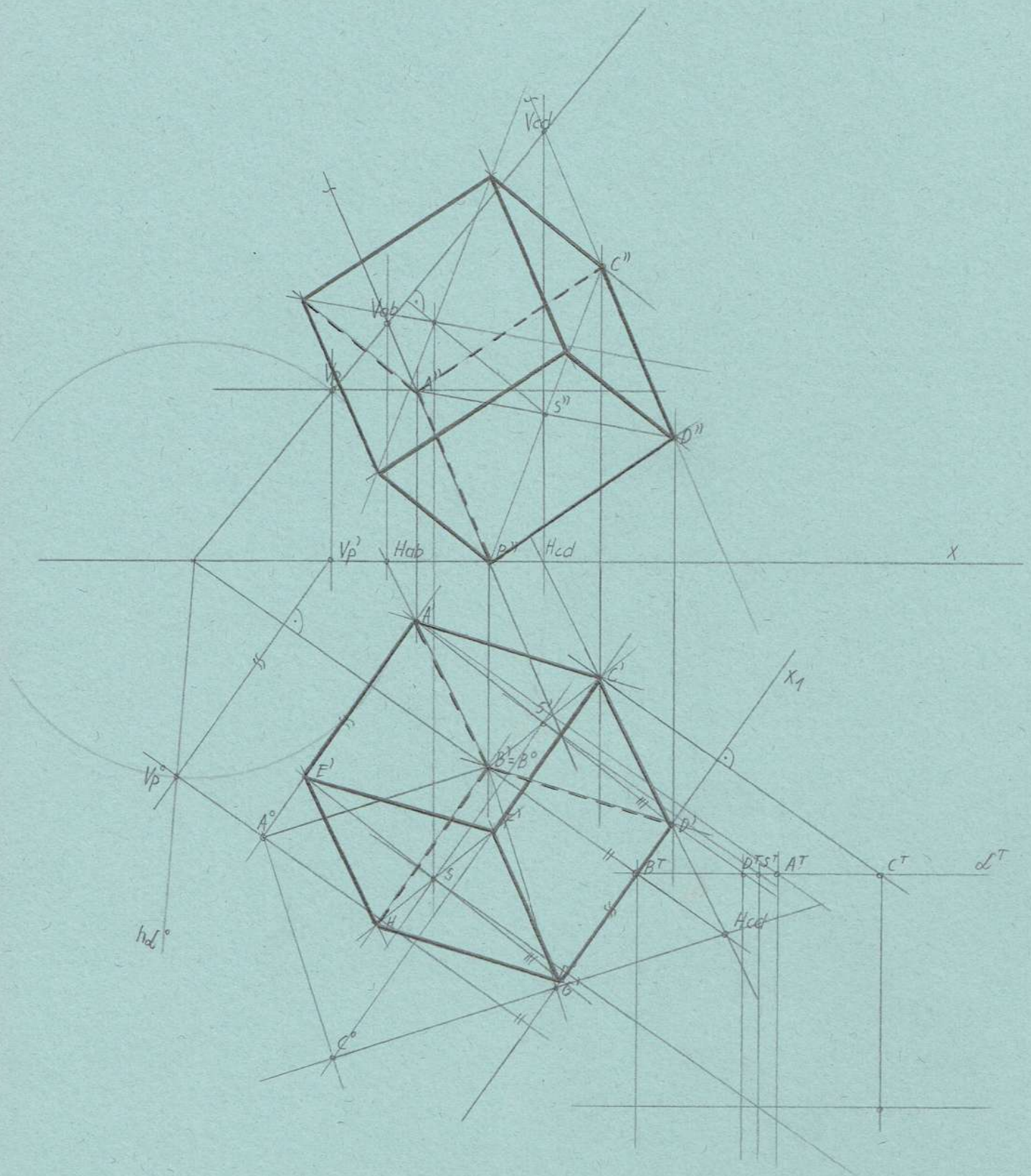

① 9/10/20



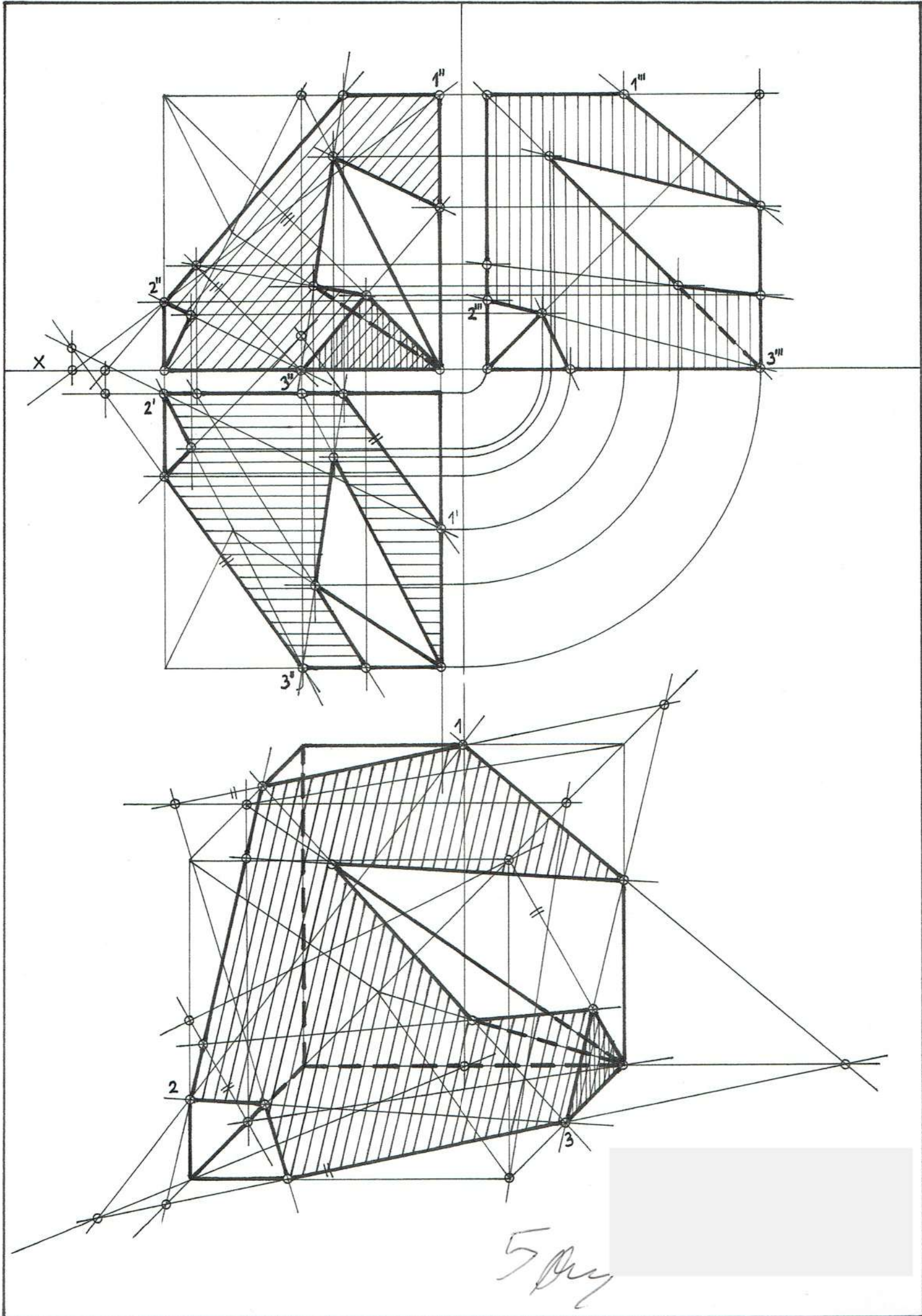

5 Aug

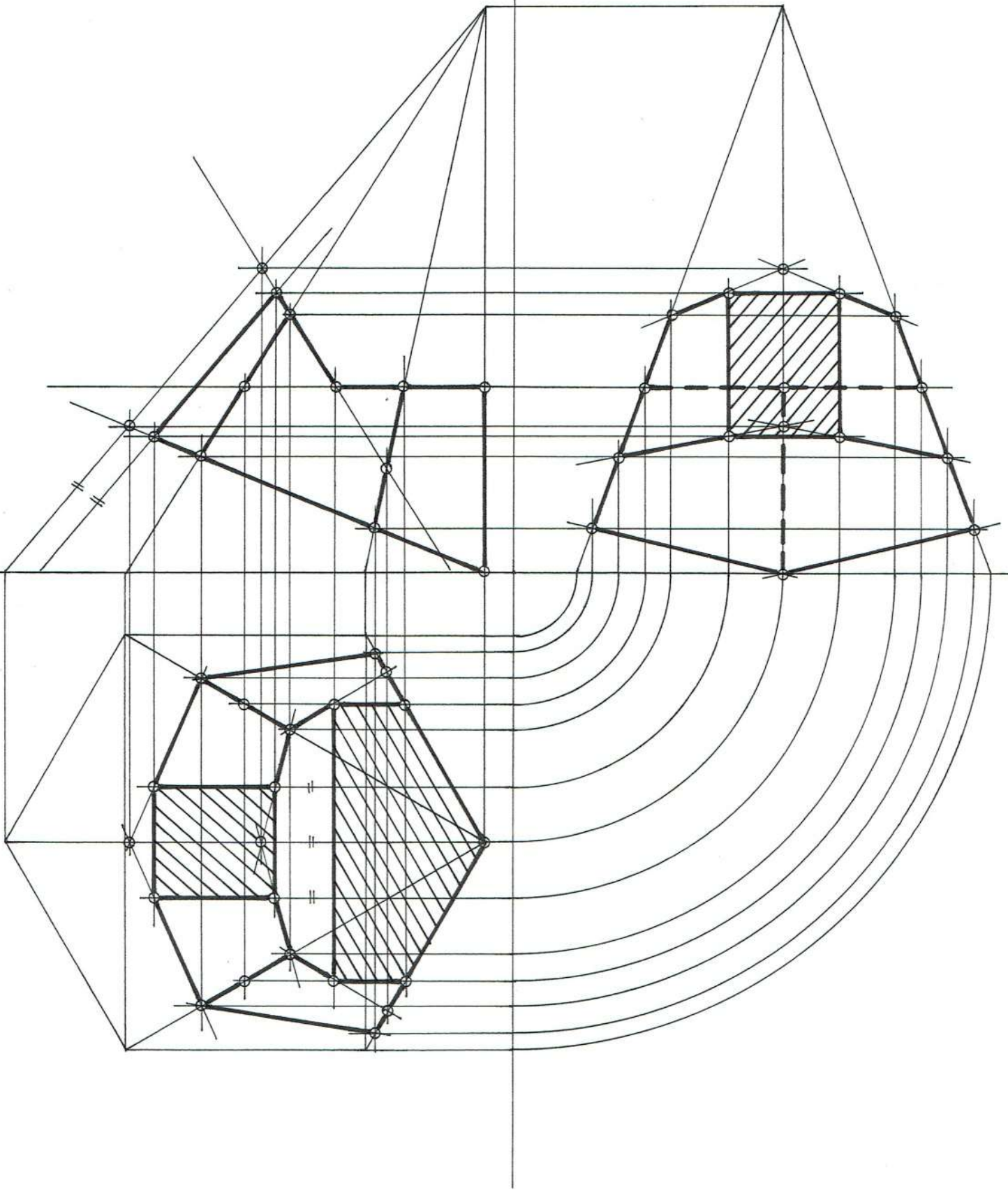

4.5/23

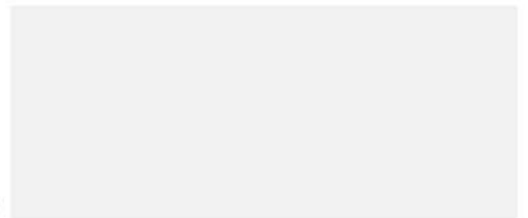

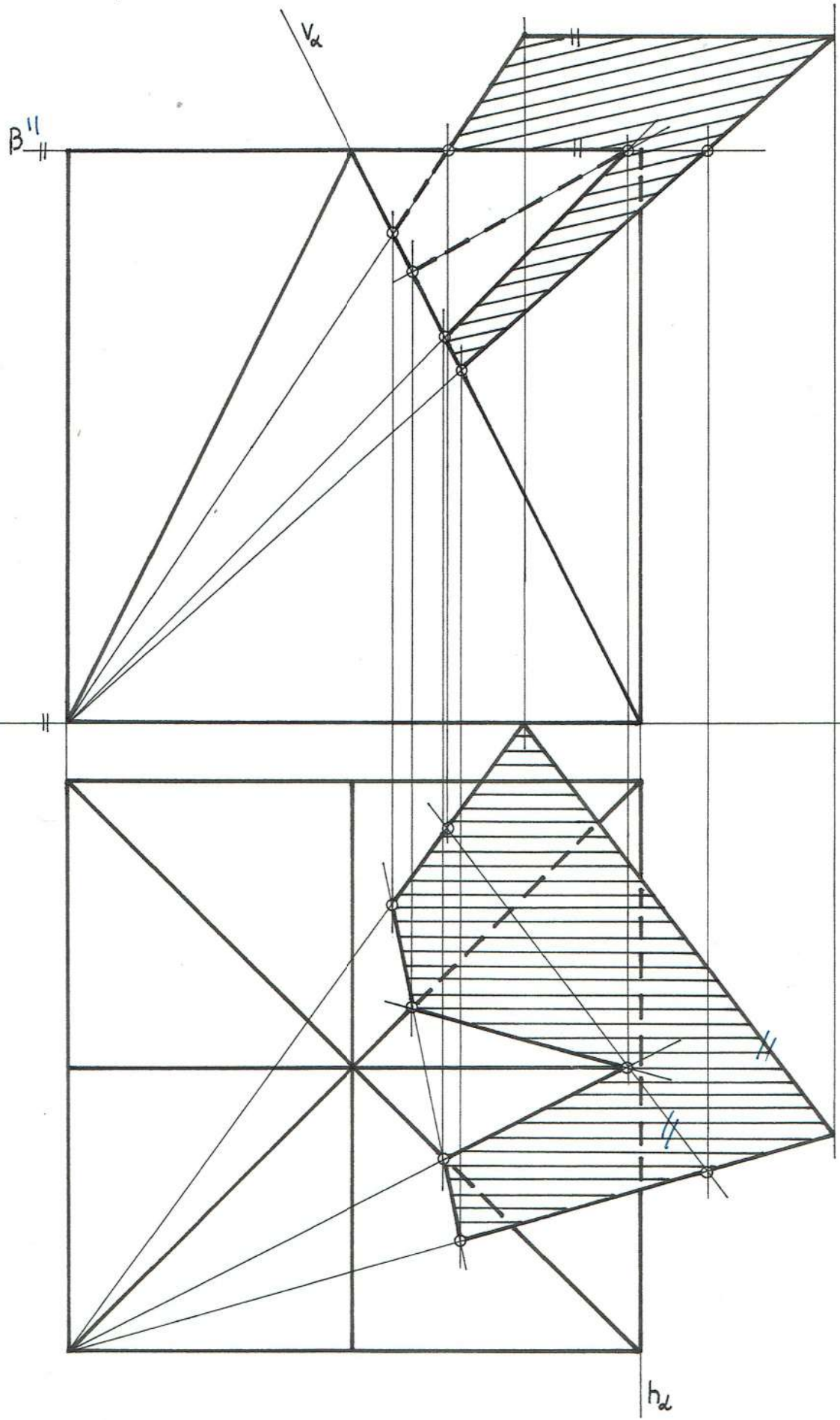

4.5 Aug

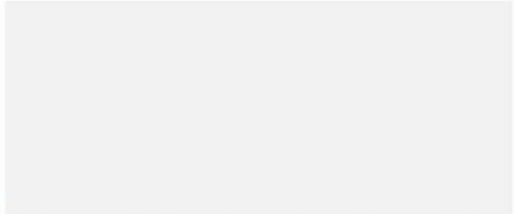

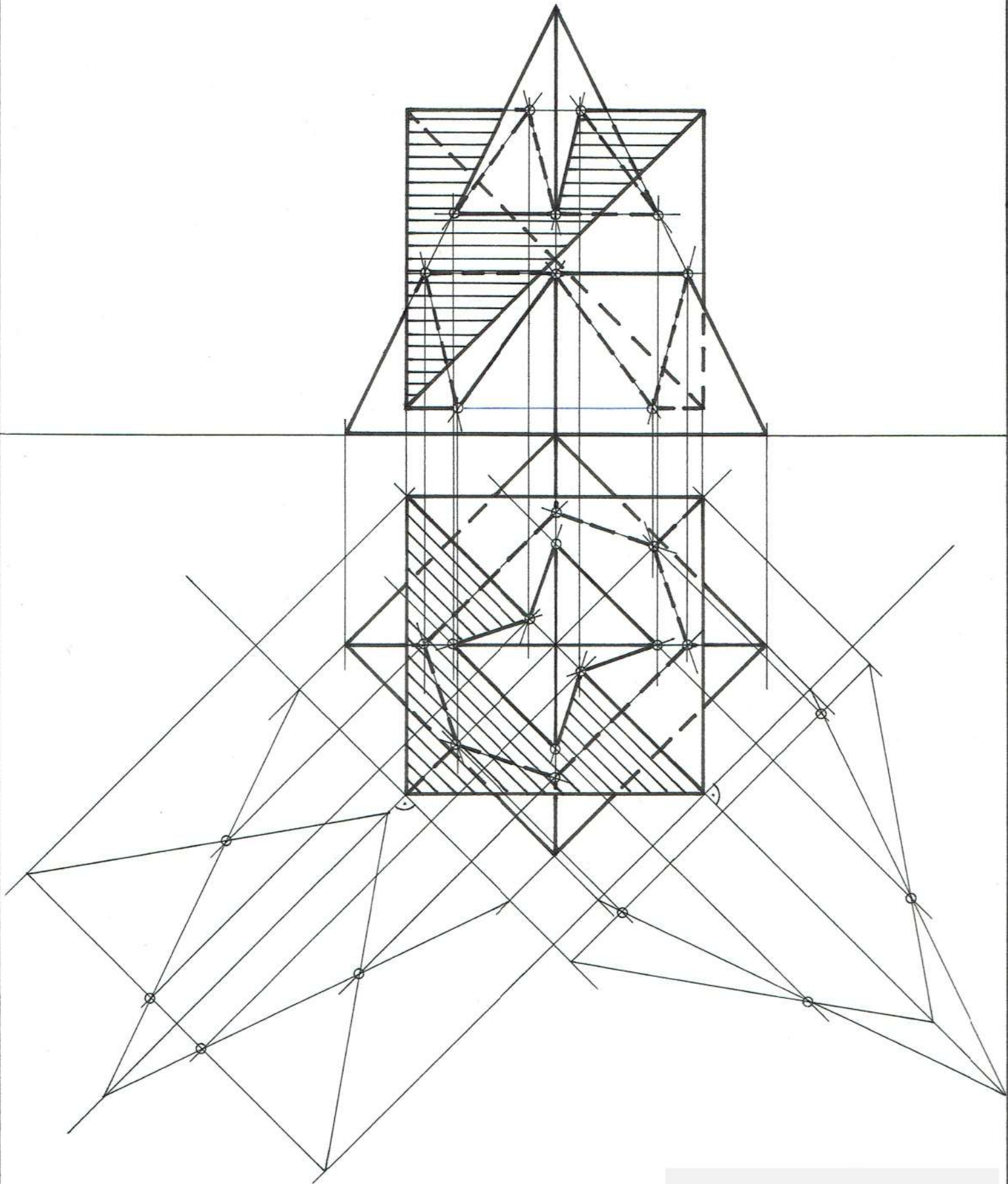

4.5/22

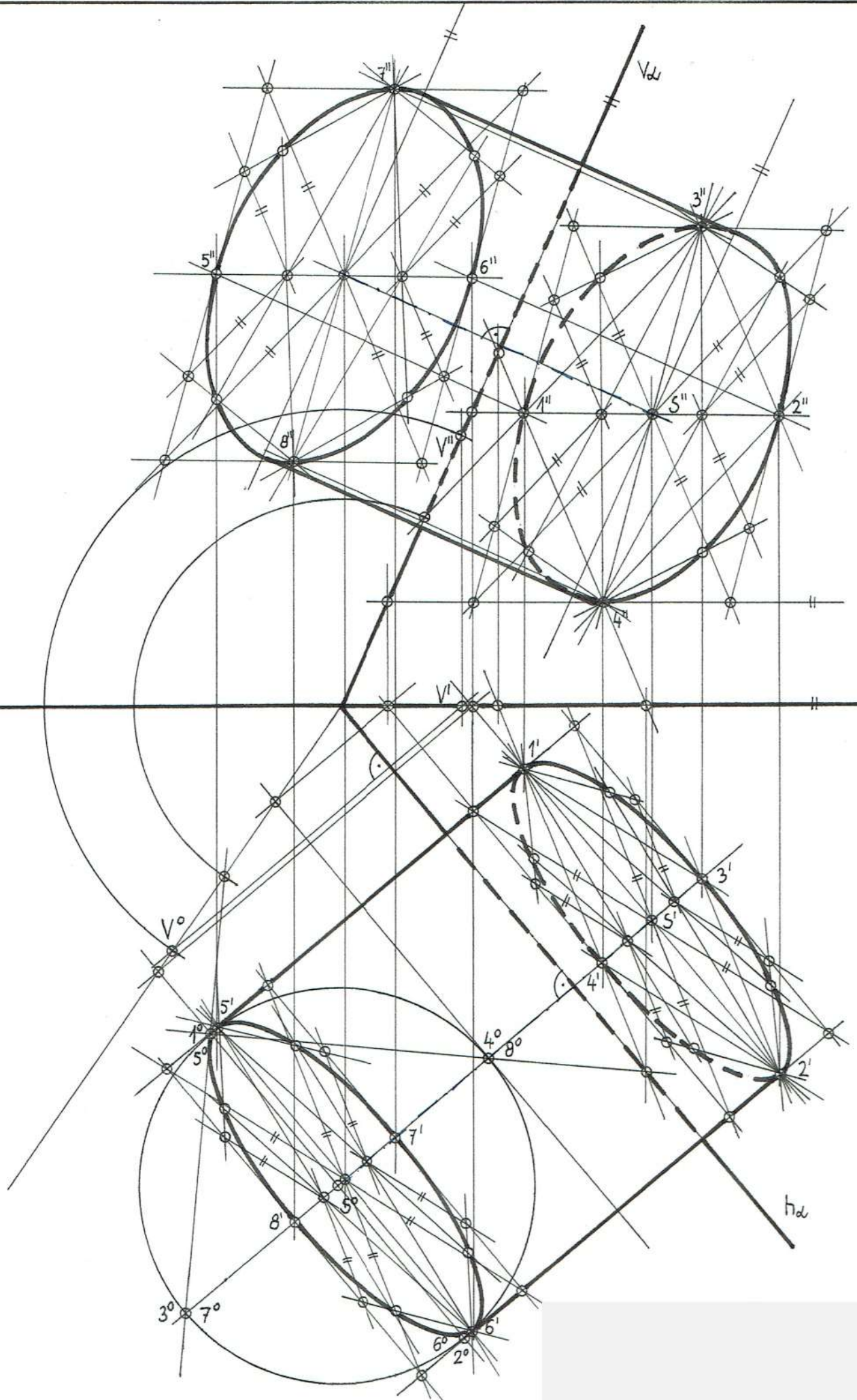

X

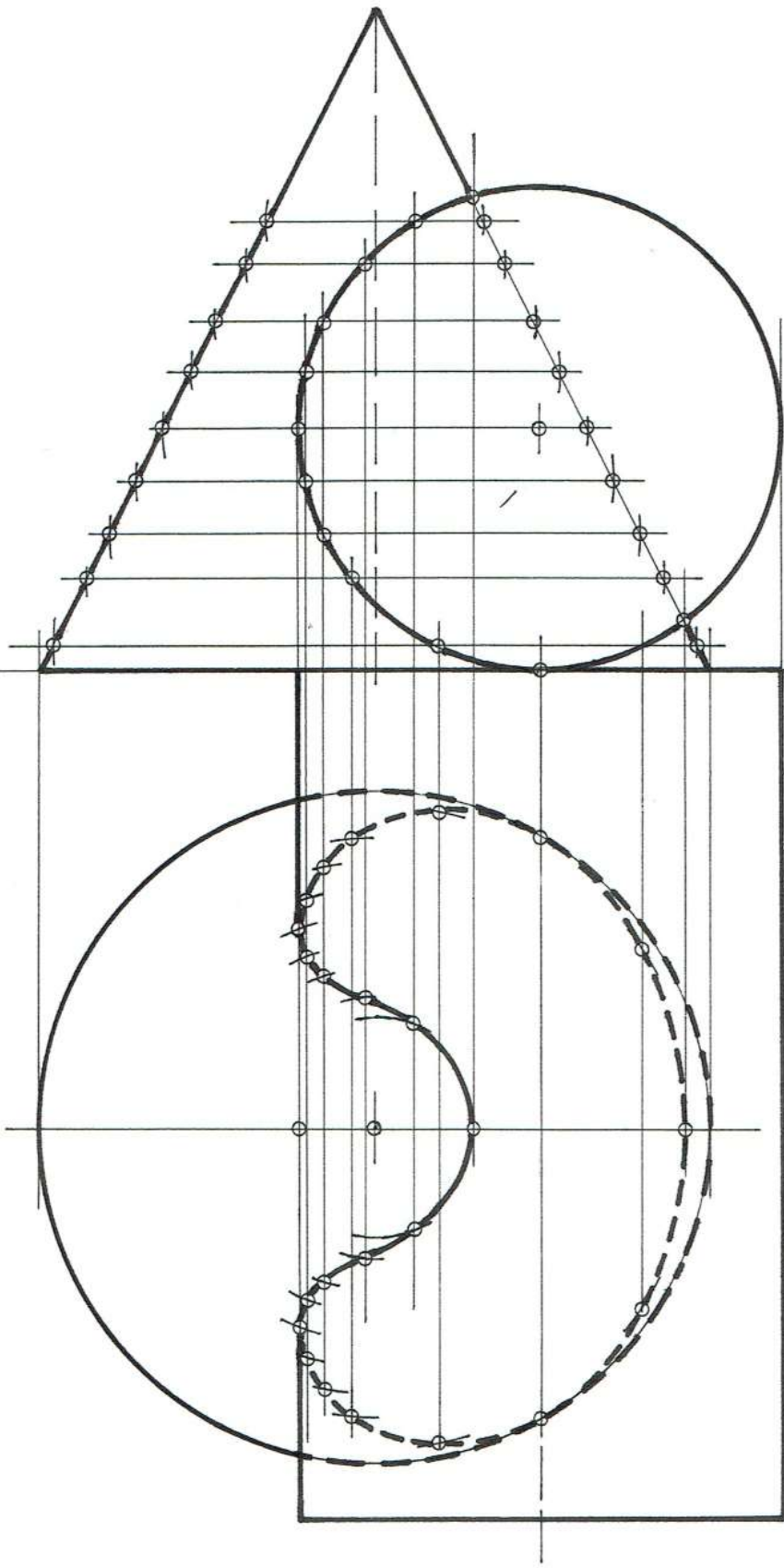

5

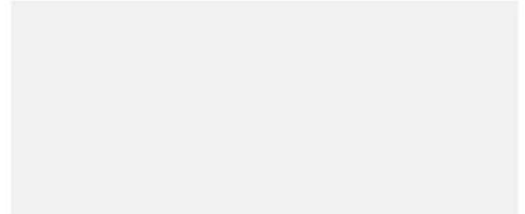

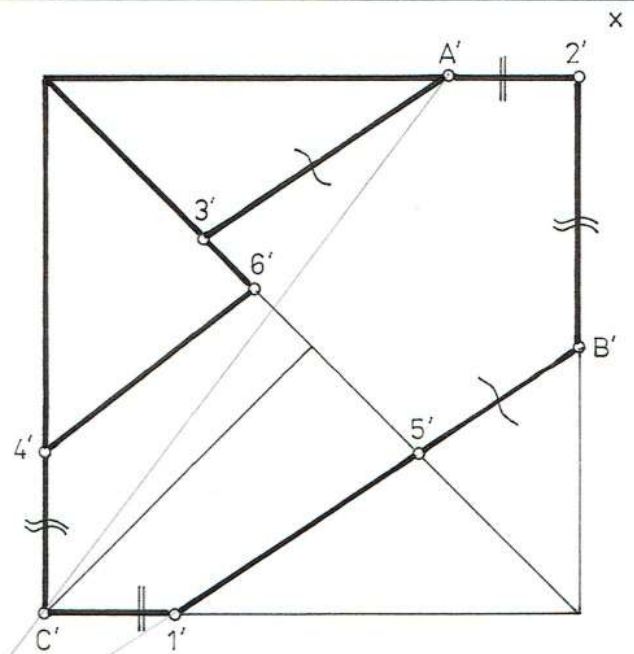
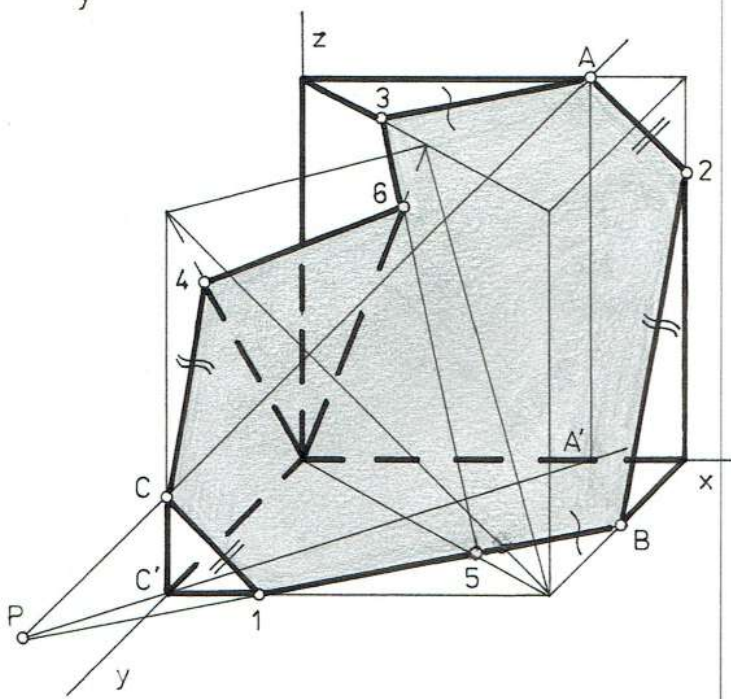
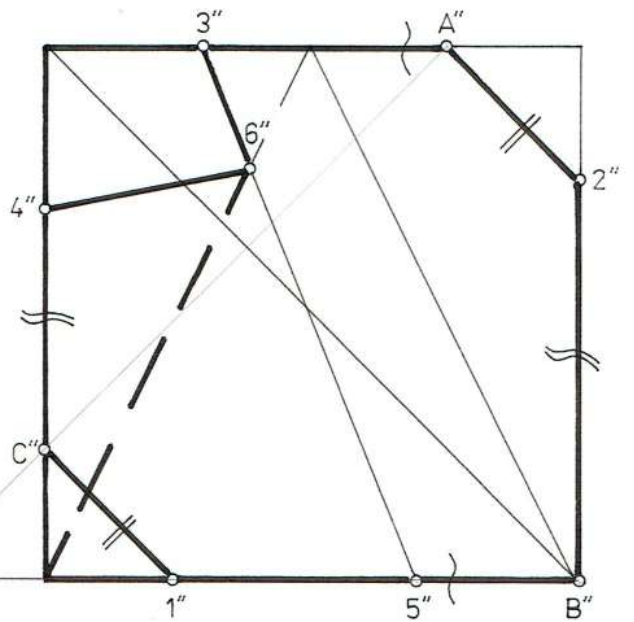
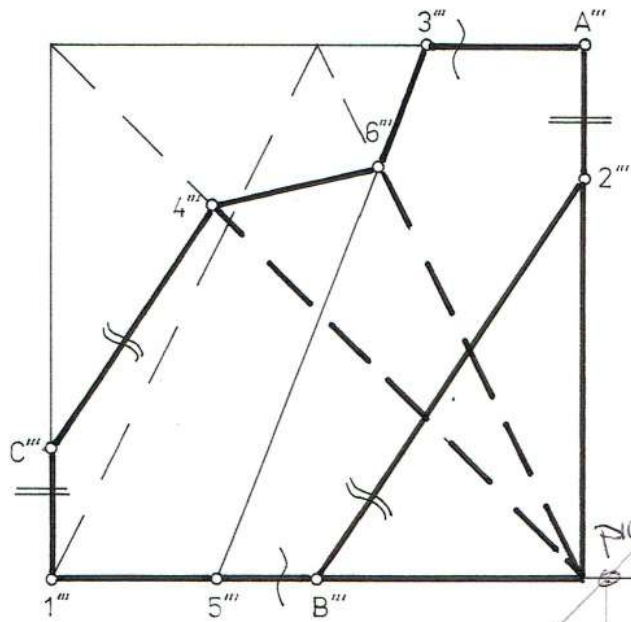

7-04

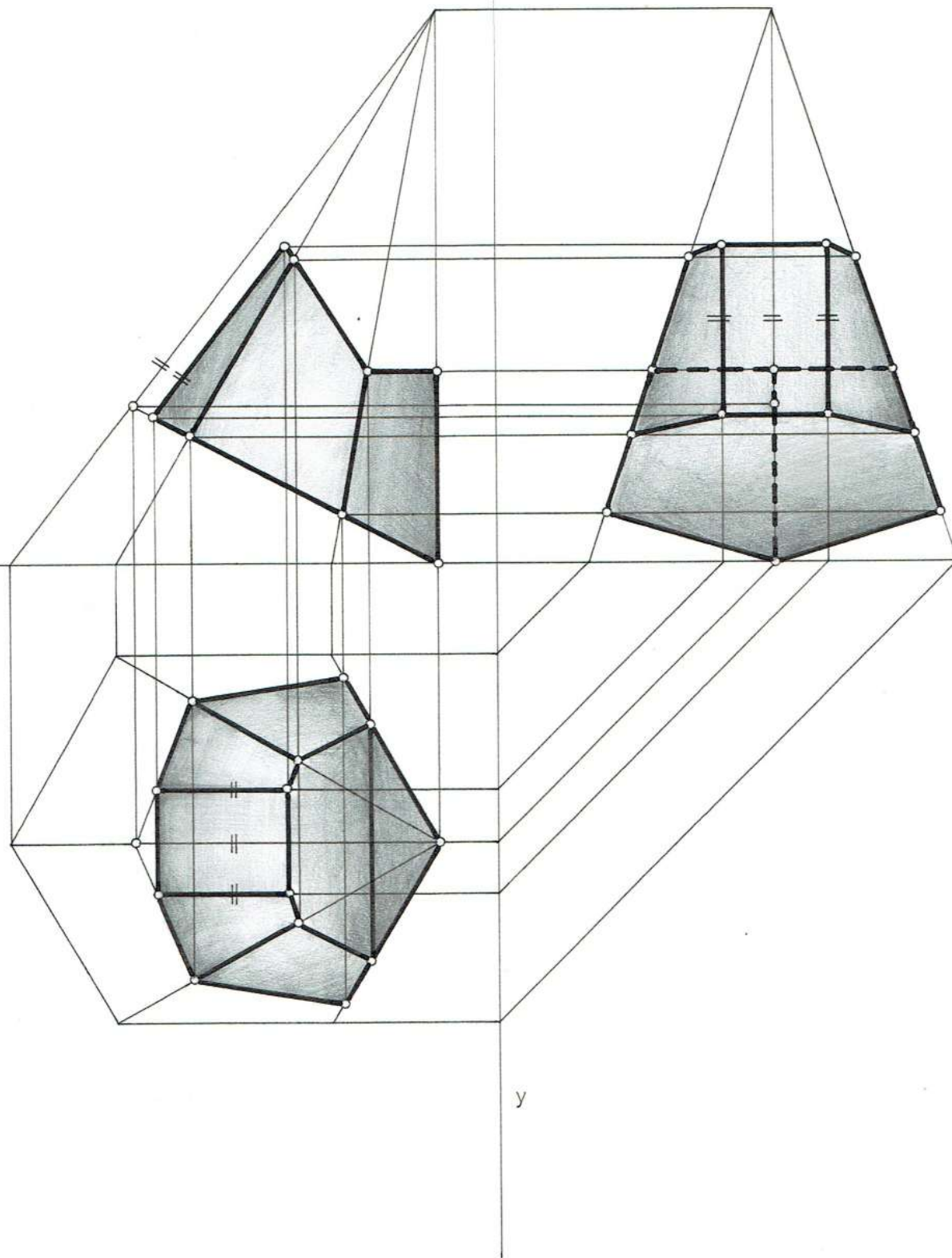

x

z

y

y

4,5 puz

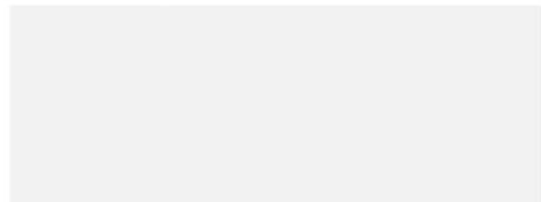

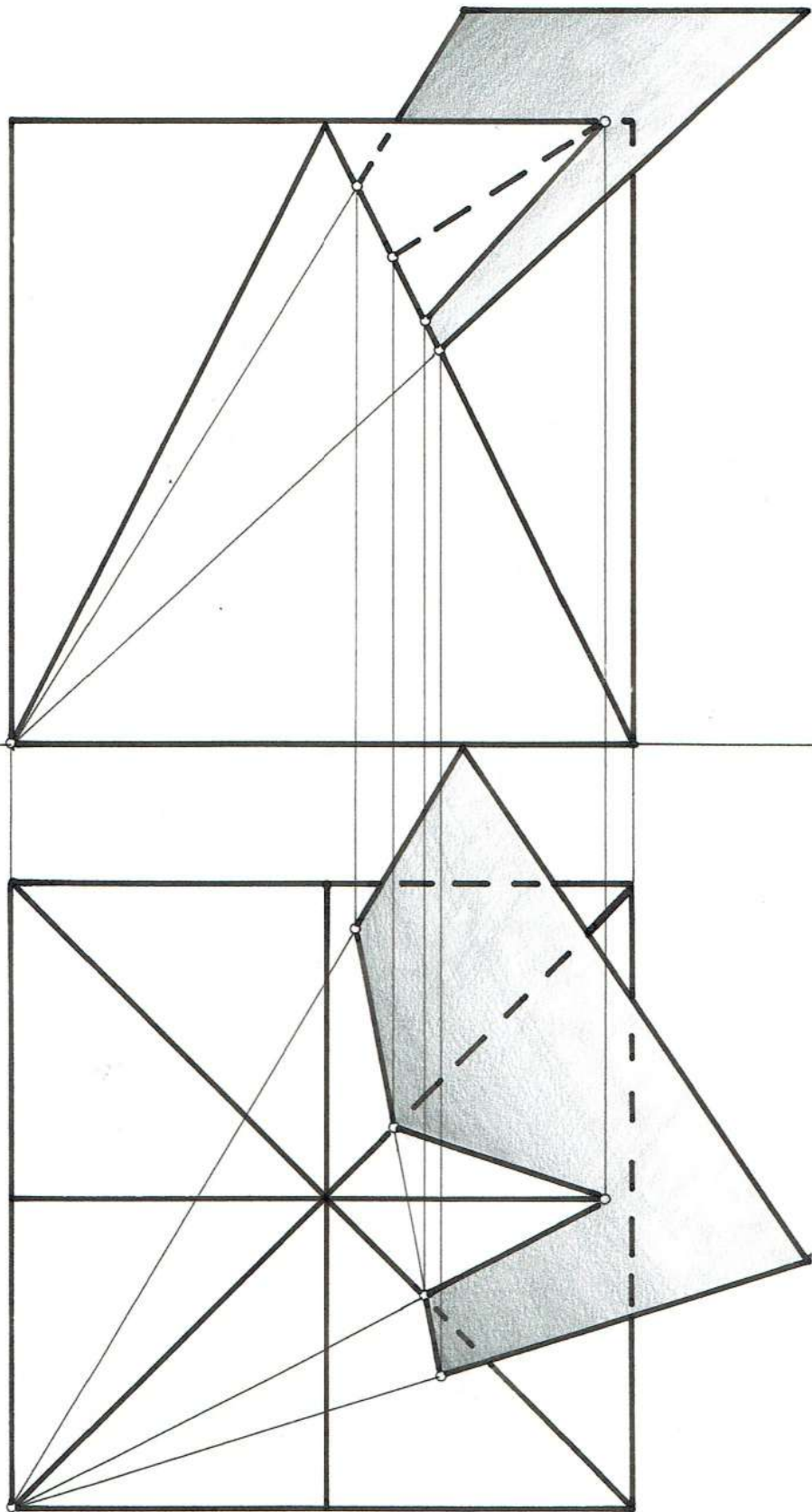

5-2017

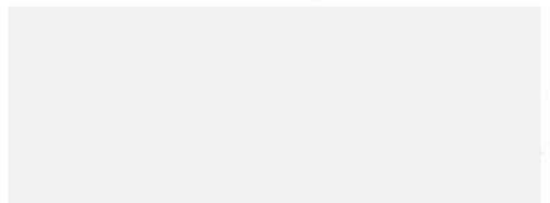

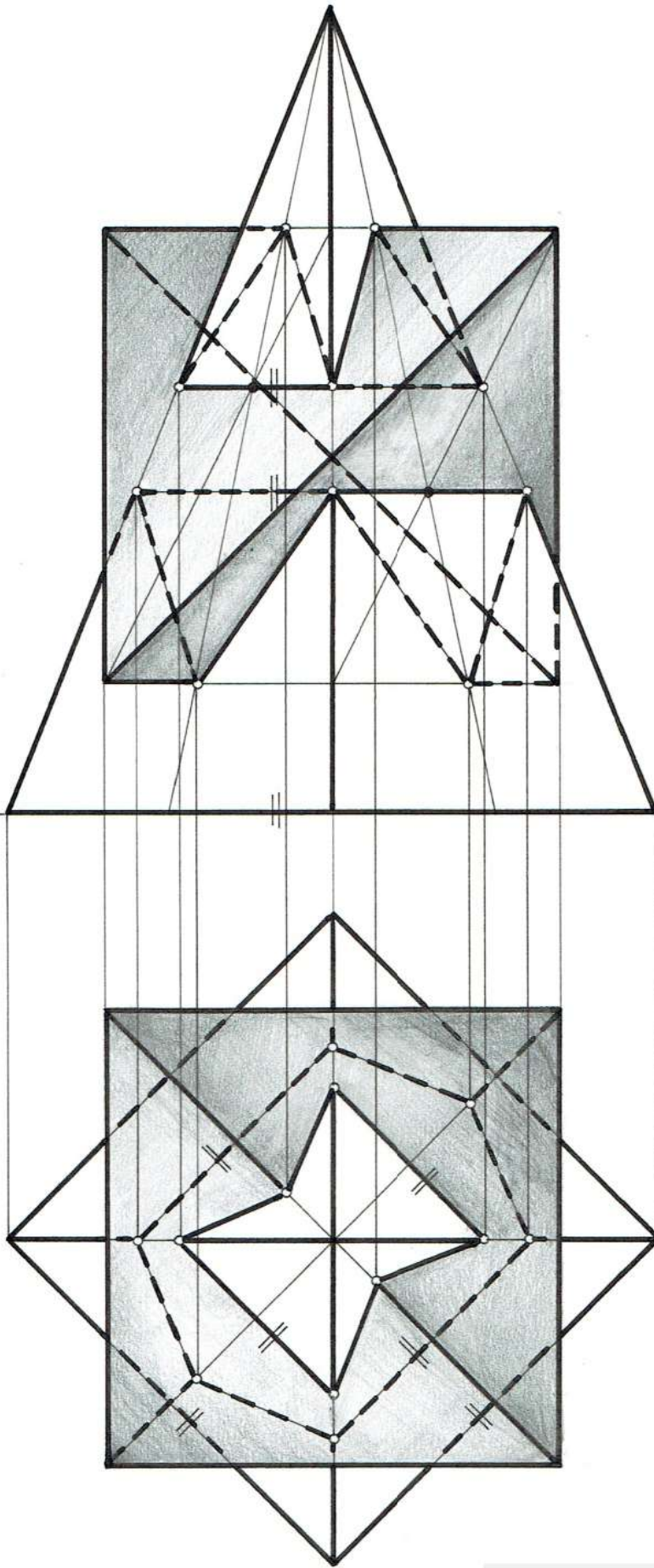

x

John

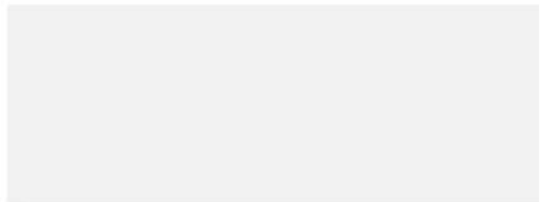

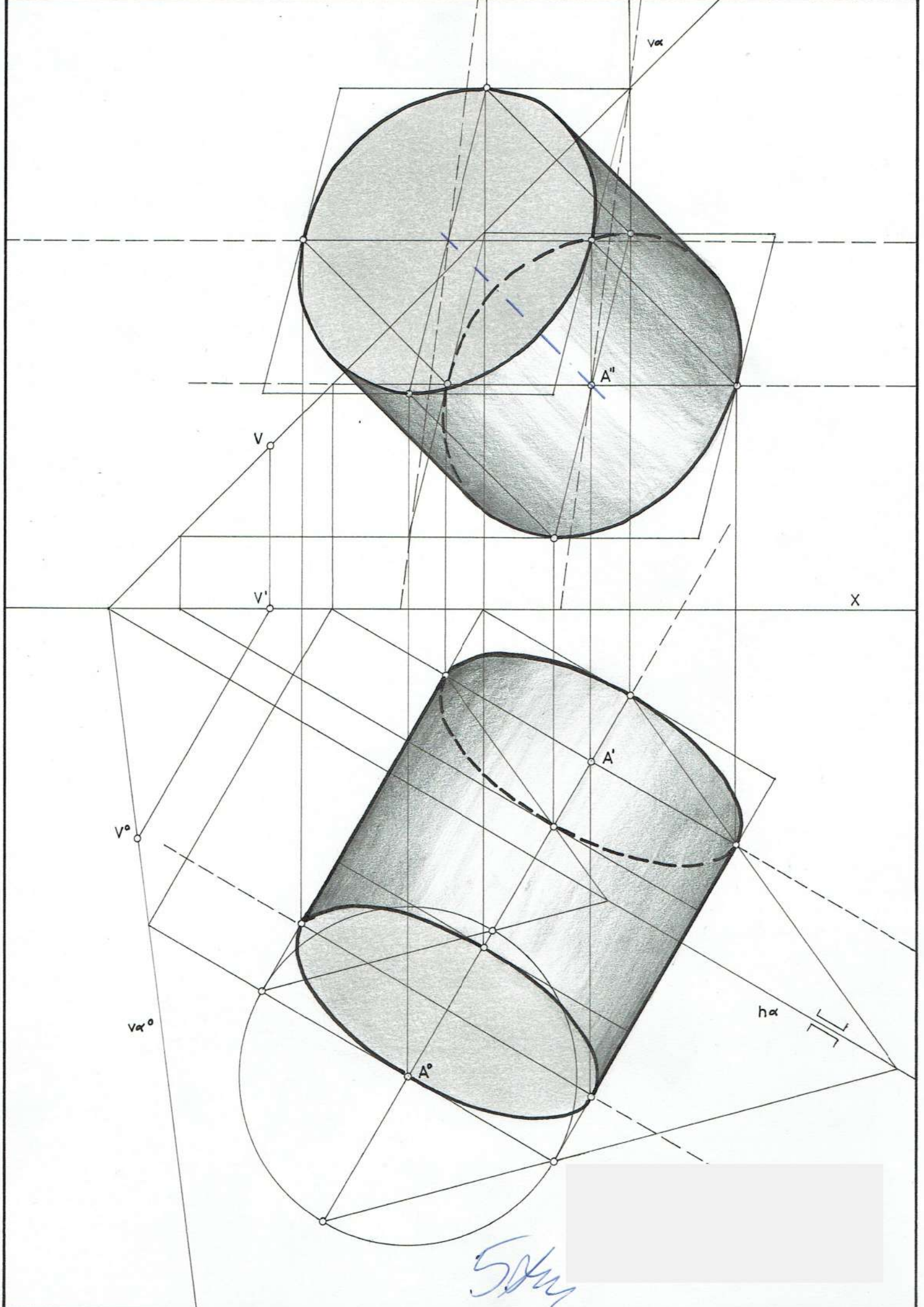

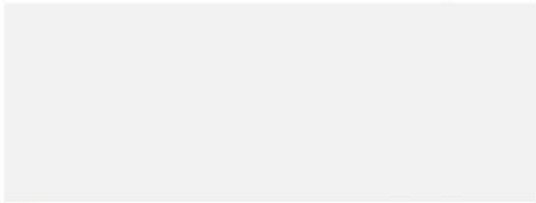
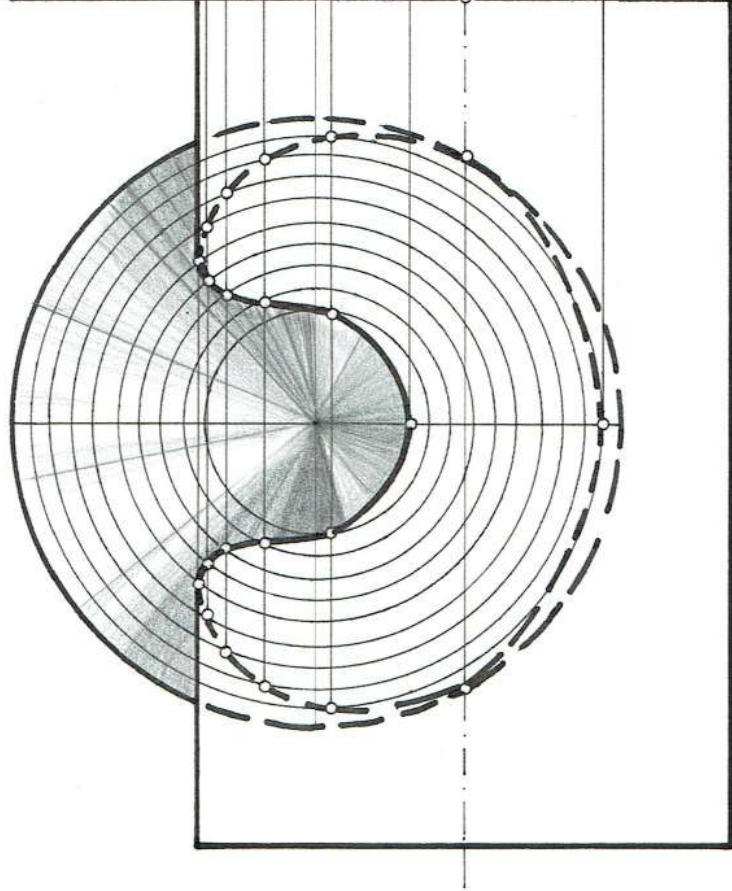
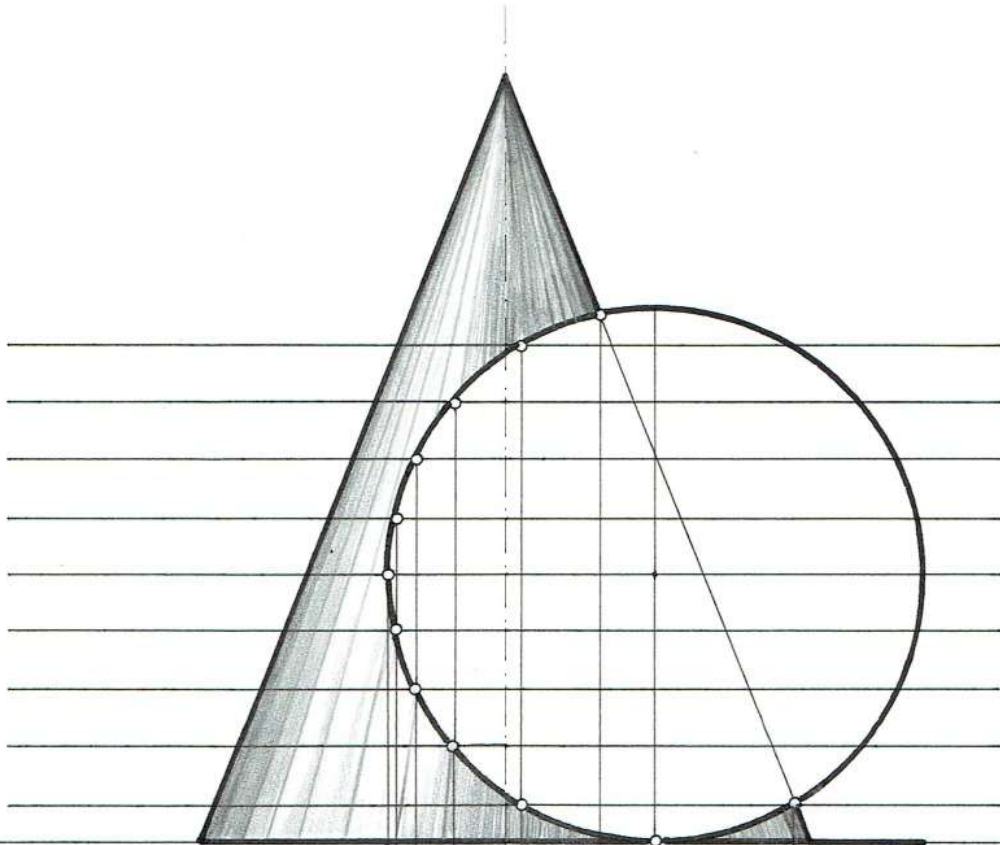

5

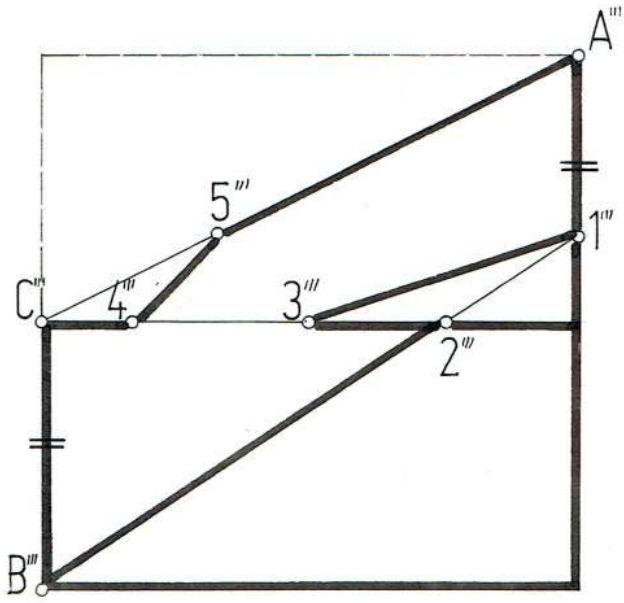

Z

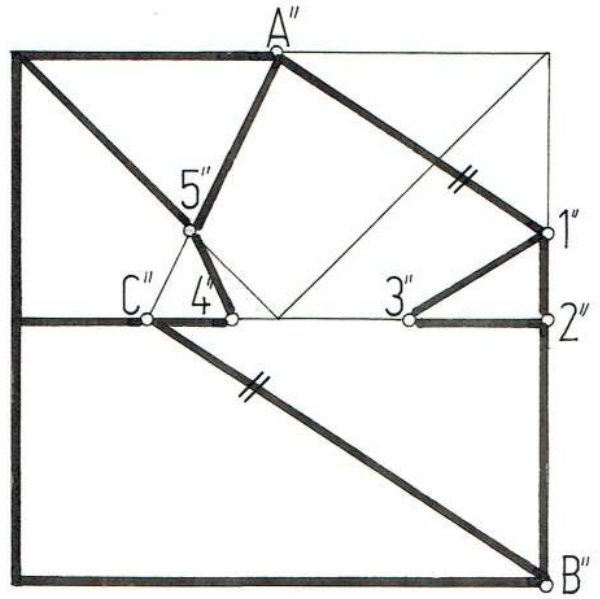

X

Y

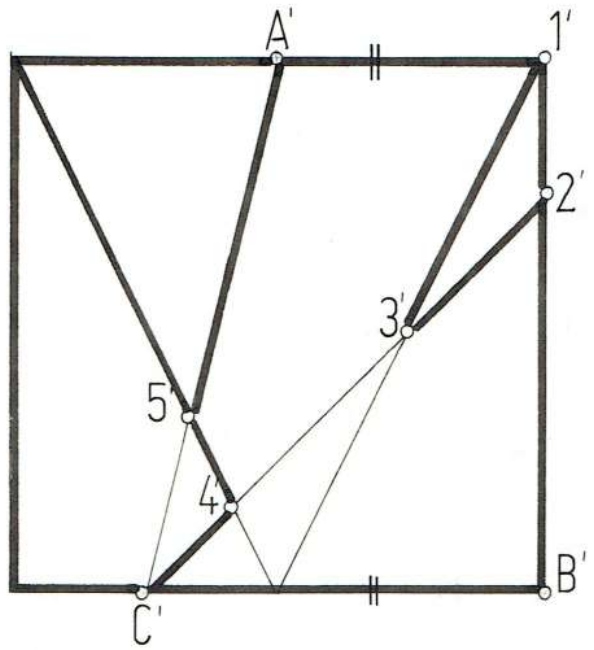
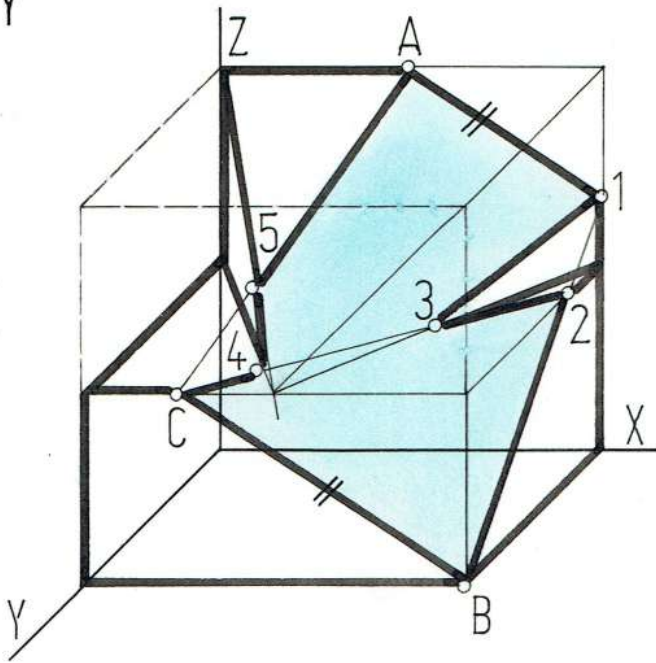

Y

5 Aug

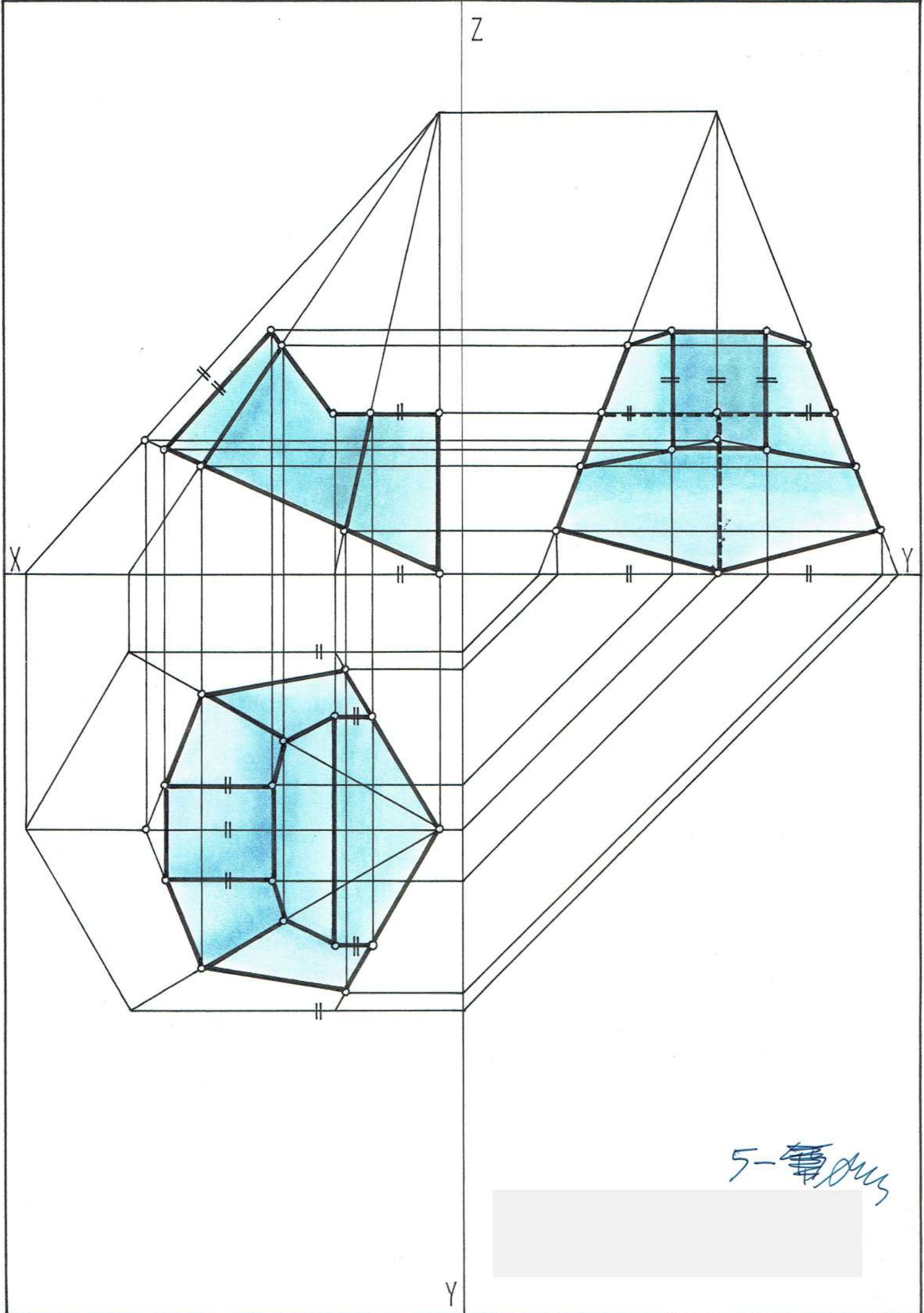

5-第0113



Y

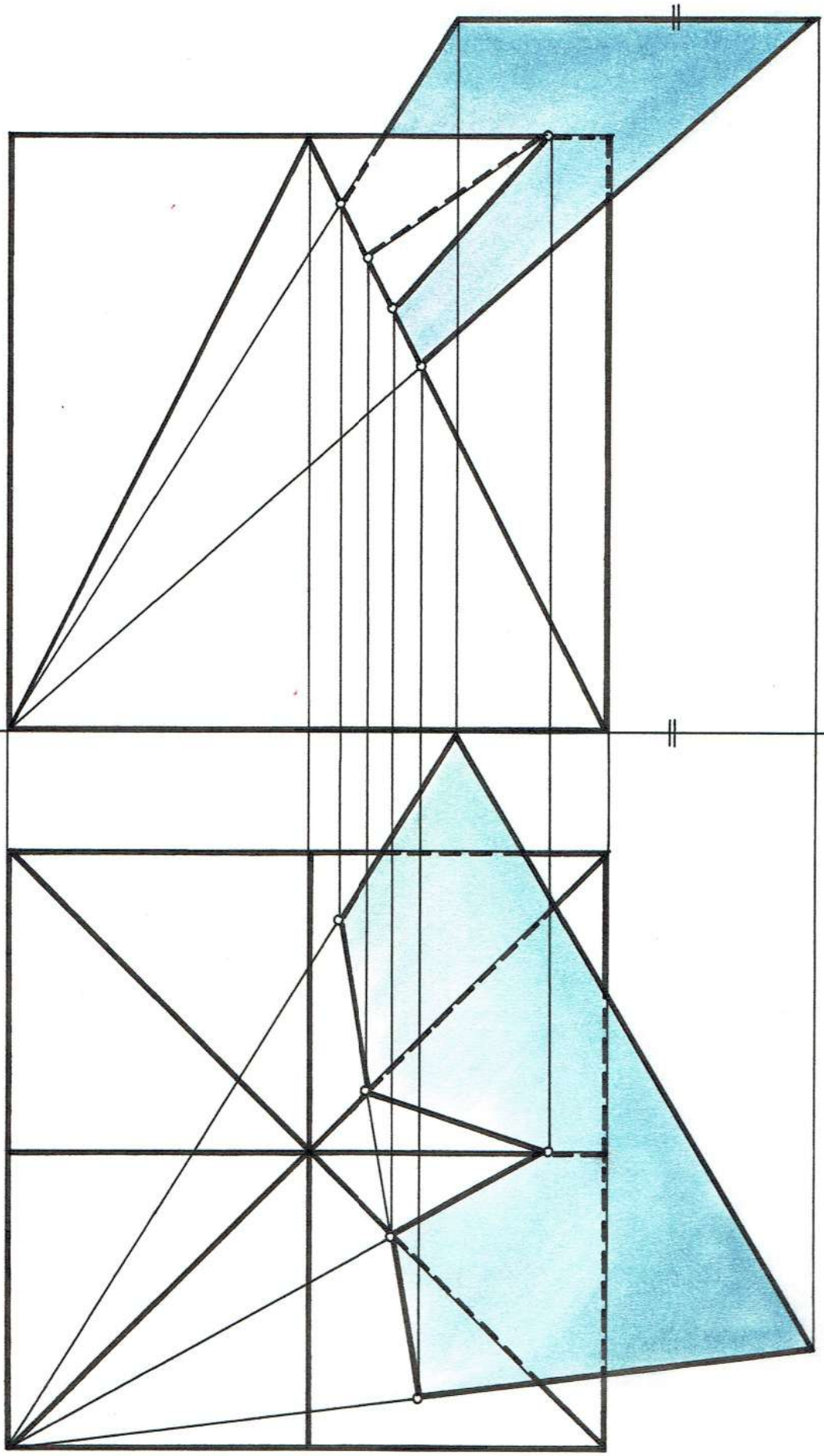

X

II

5 Aug

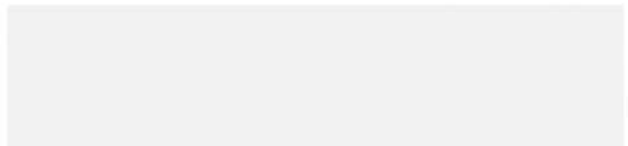

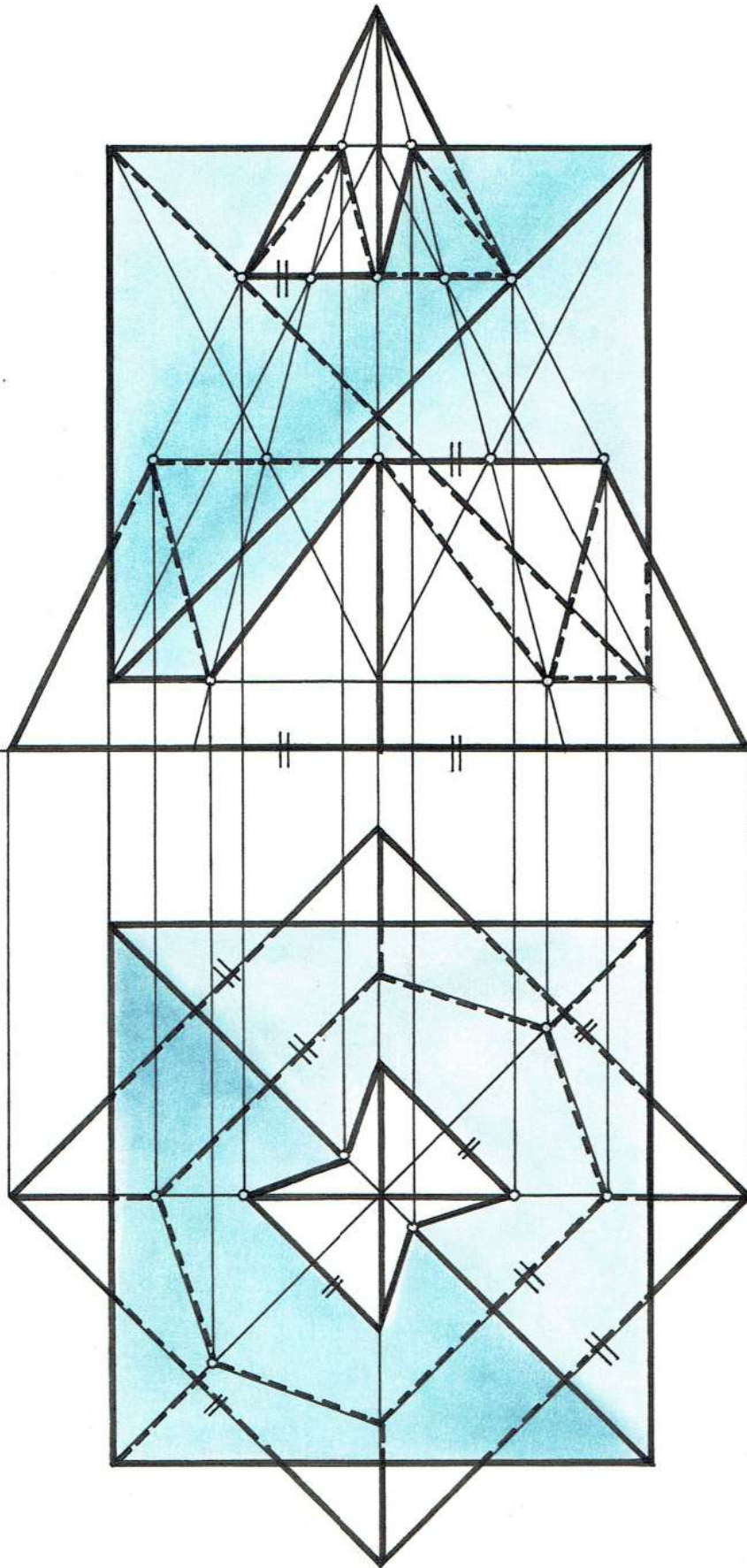

X

5 Aug

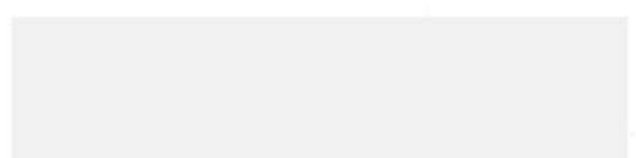

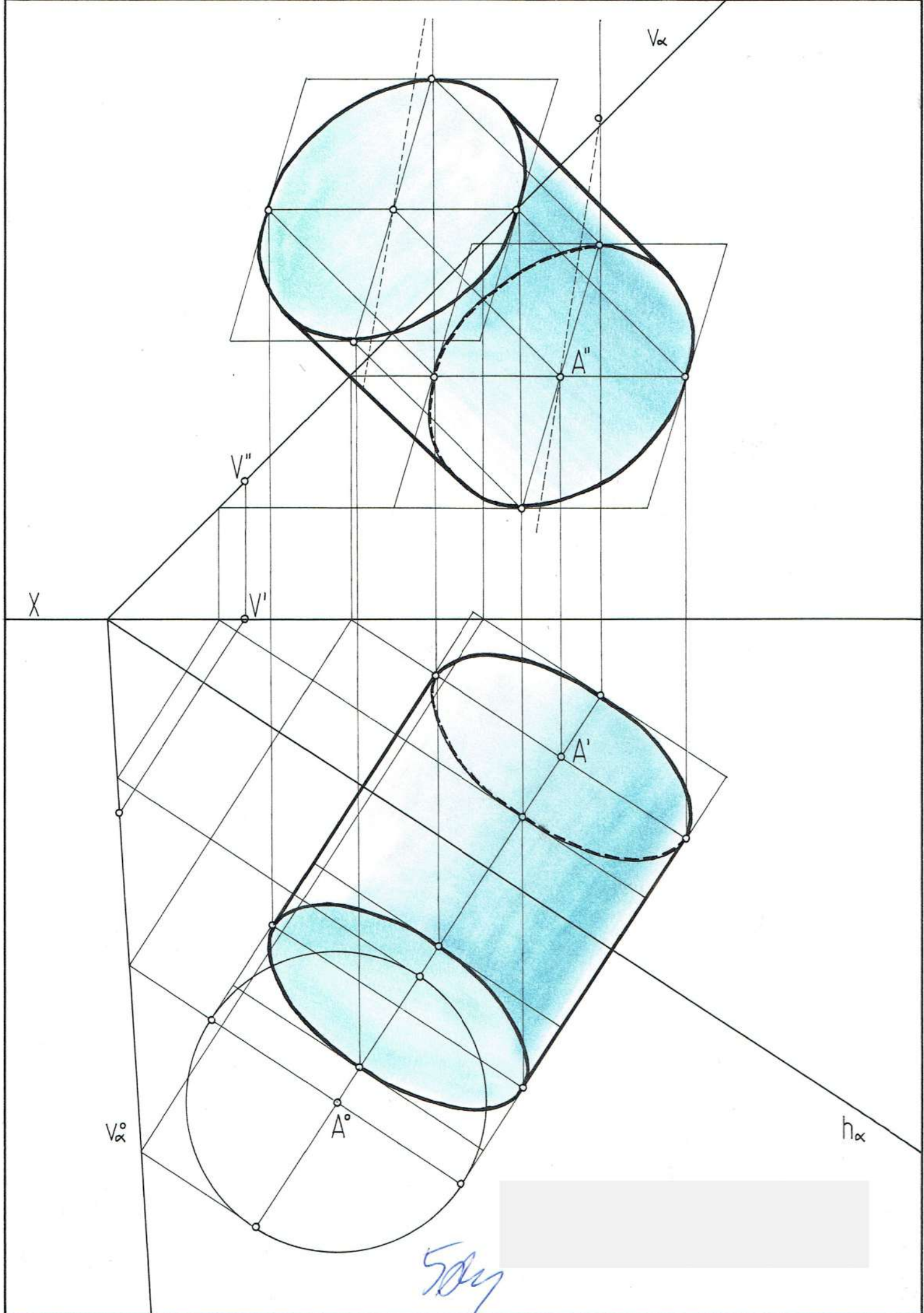

504

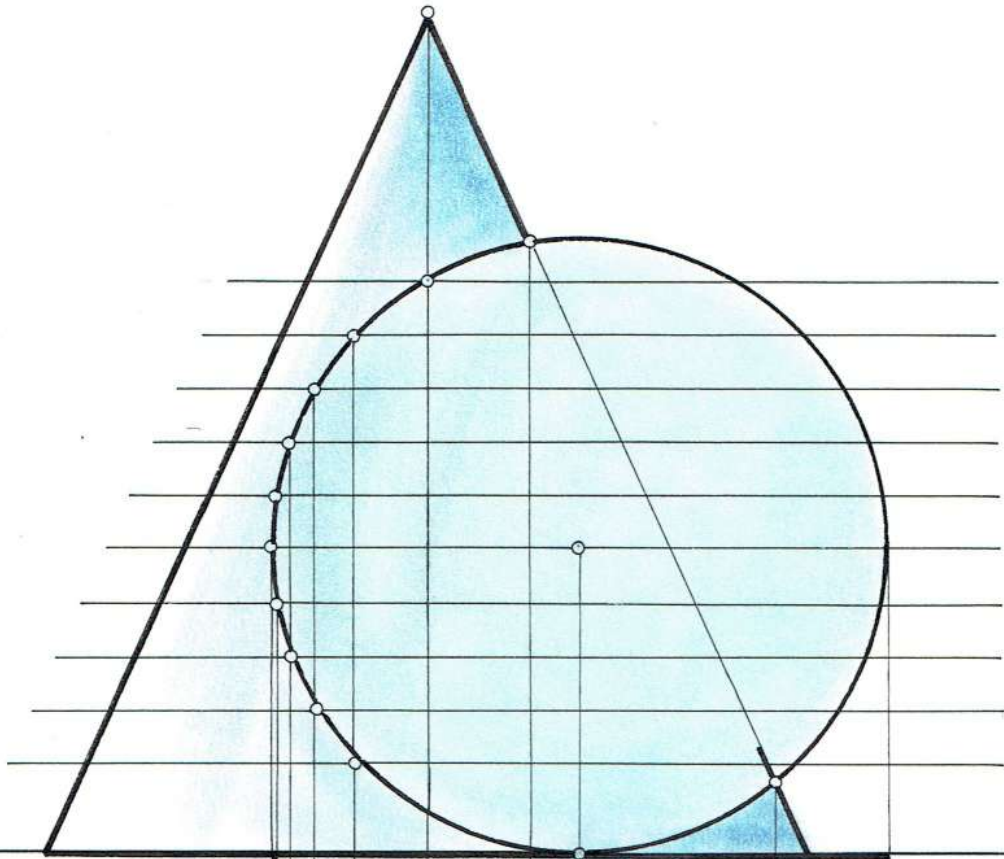

X

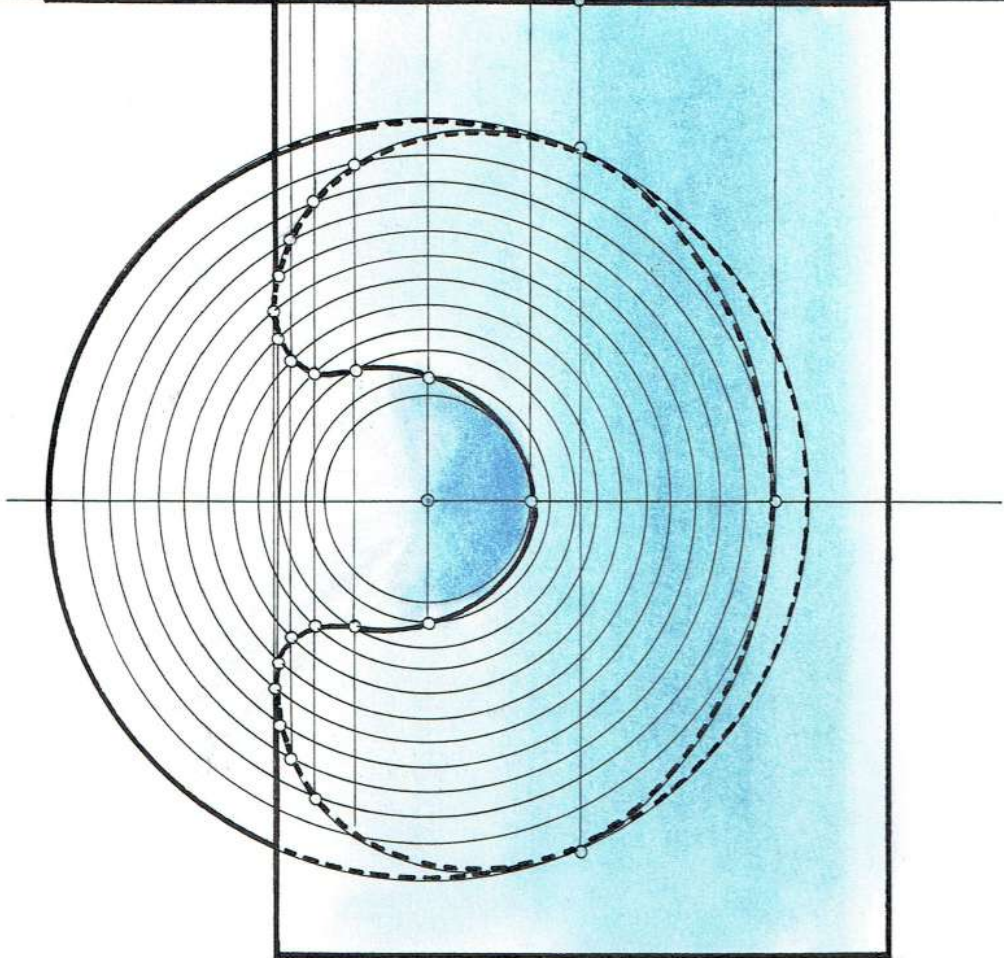

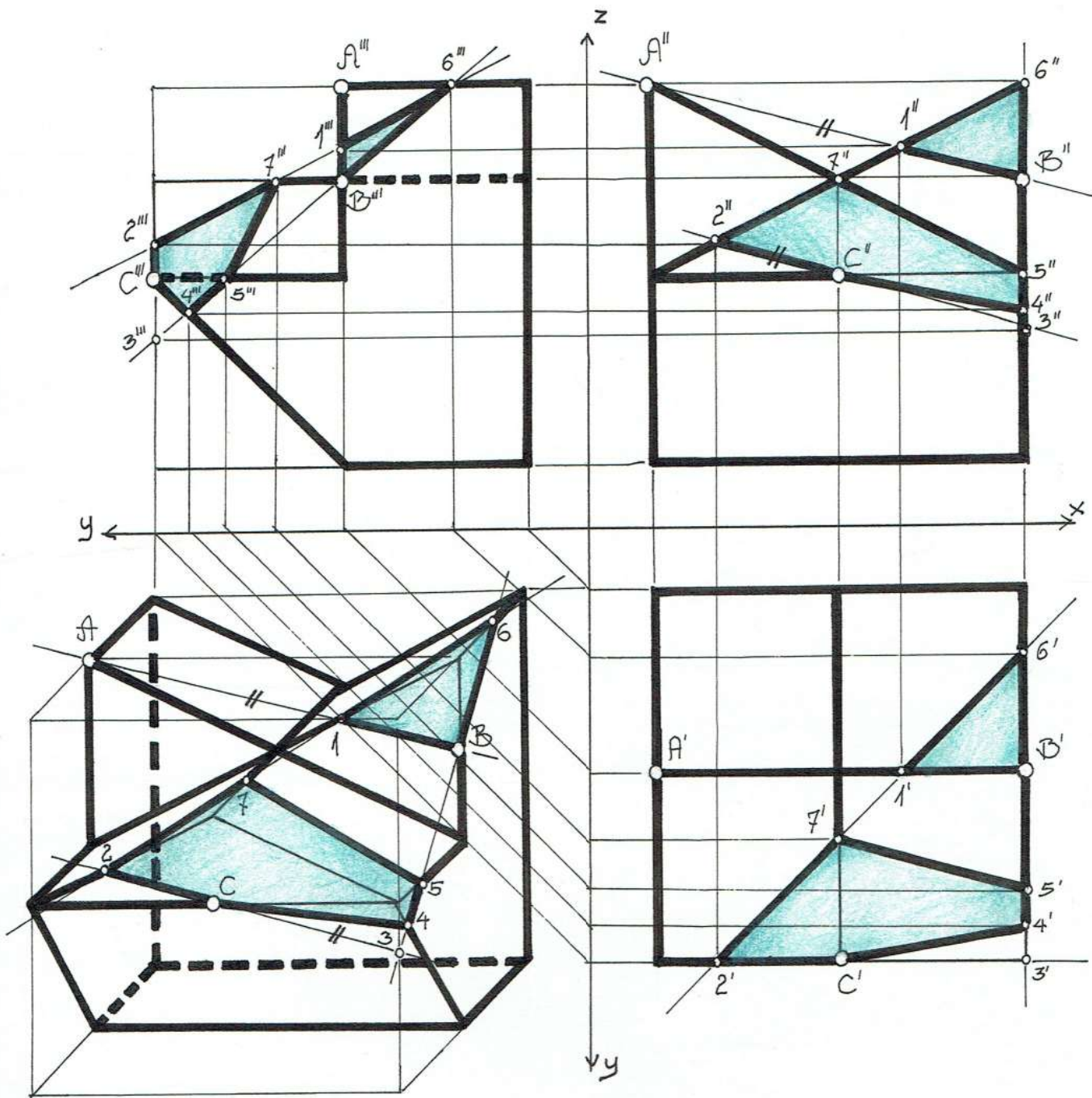

5 plm

Wydział Architektury
 Rok 1. Gr. 3 R.A 98/99
 Arkusz Nr. 1.

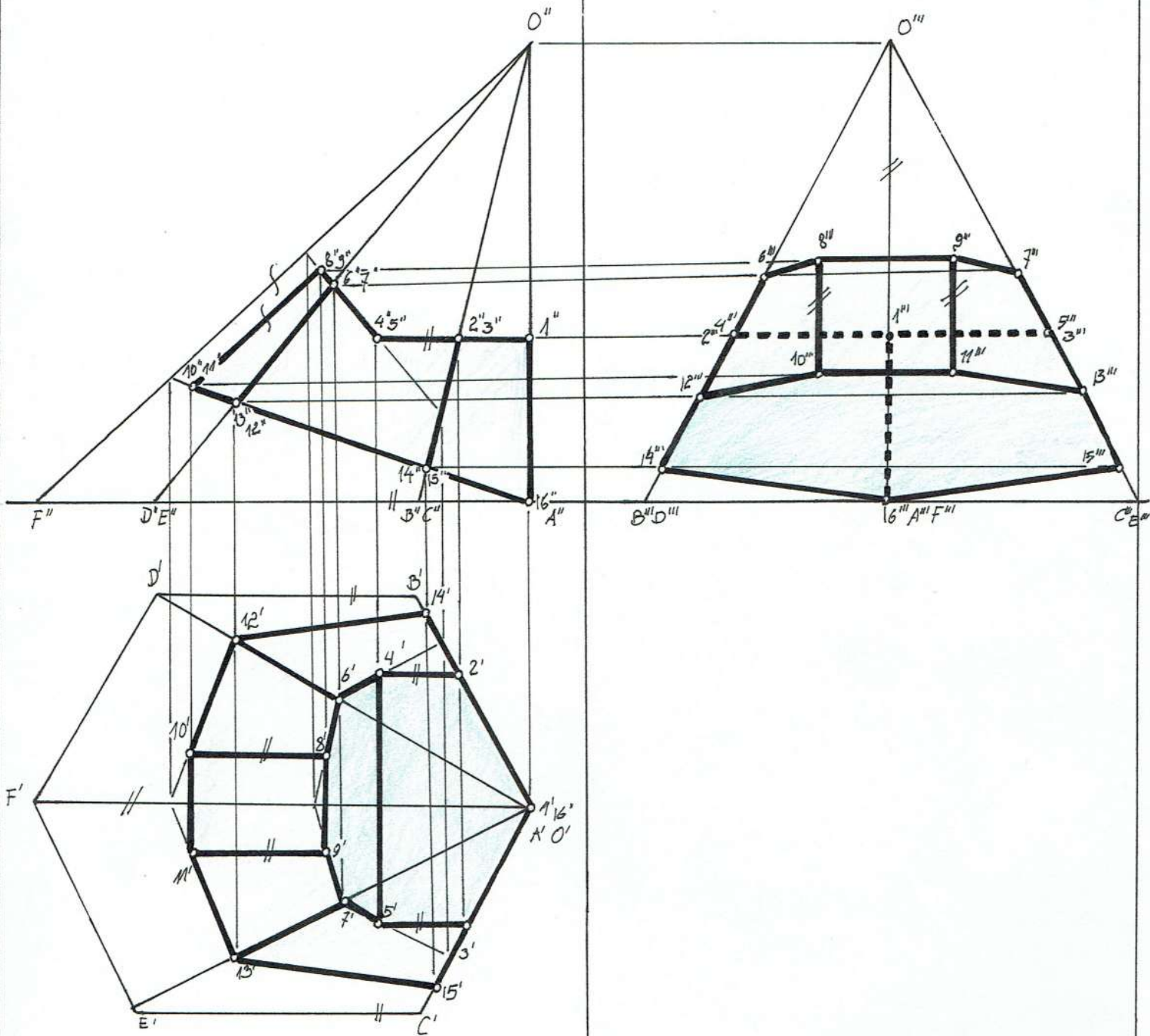

 - widoczne pozostałe ściany ostrosłupa

 - widoczne płaszczyzny wykrojnic

Wyciół Architektury

Pol 1 Gr.3 R.S. 98/99

Arkusz nr. 2.

50my

