

ARKUSZ NR 1

ROK I GR 3 ROK AKADEM. 98/99
 WYDZIAŁ ARCHITEKTURY

Handwritten signature

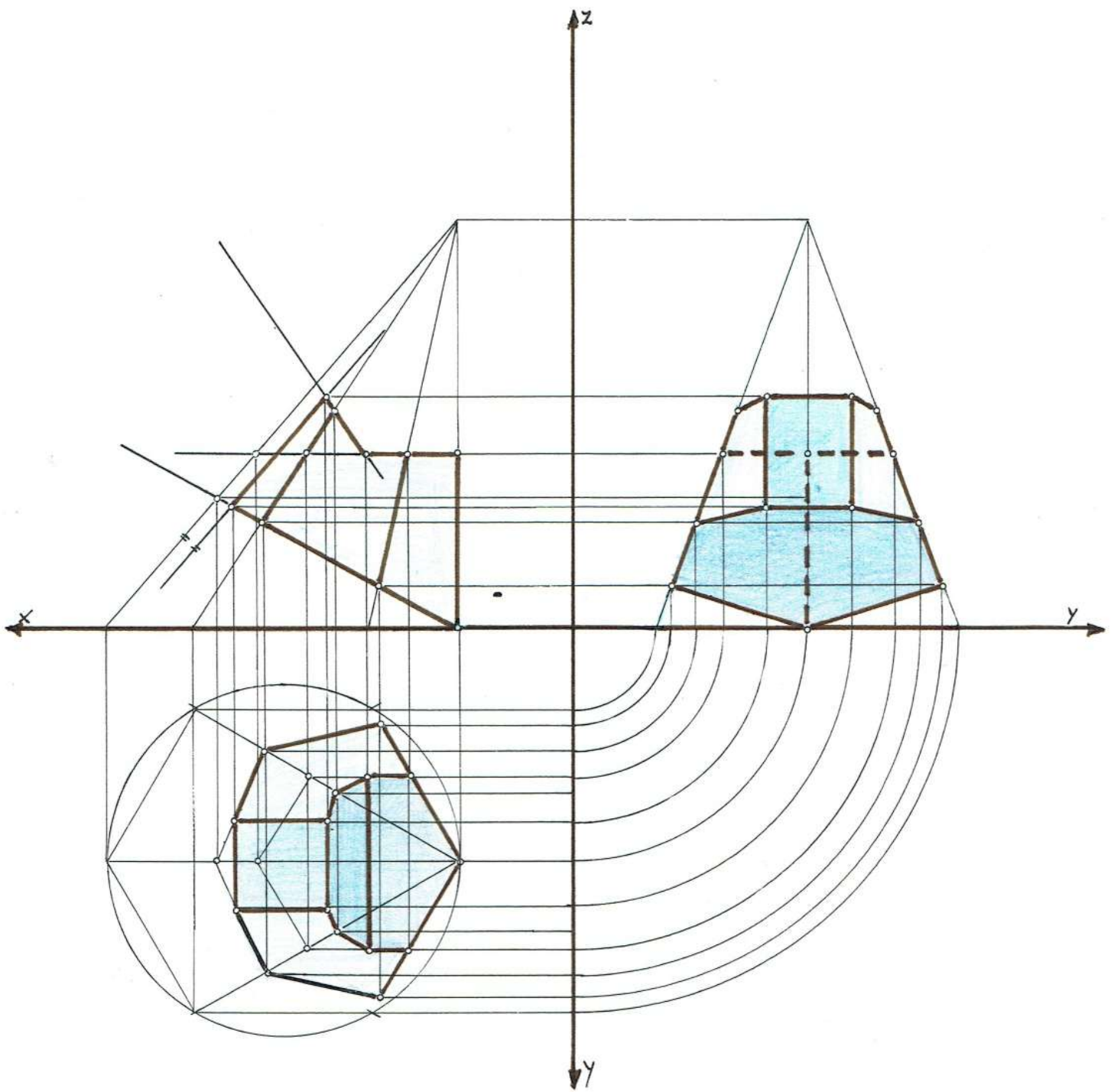

ARKUSZ NR 2

ROK I GR.3 ROK AKADEMICKI 98/99

WYDZIAŁ ARCHITEKTURY

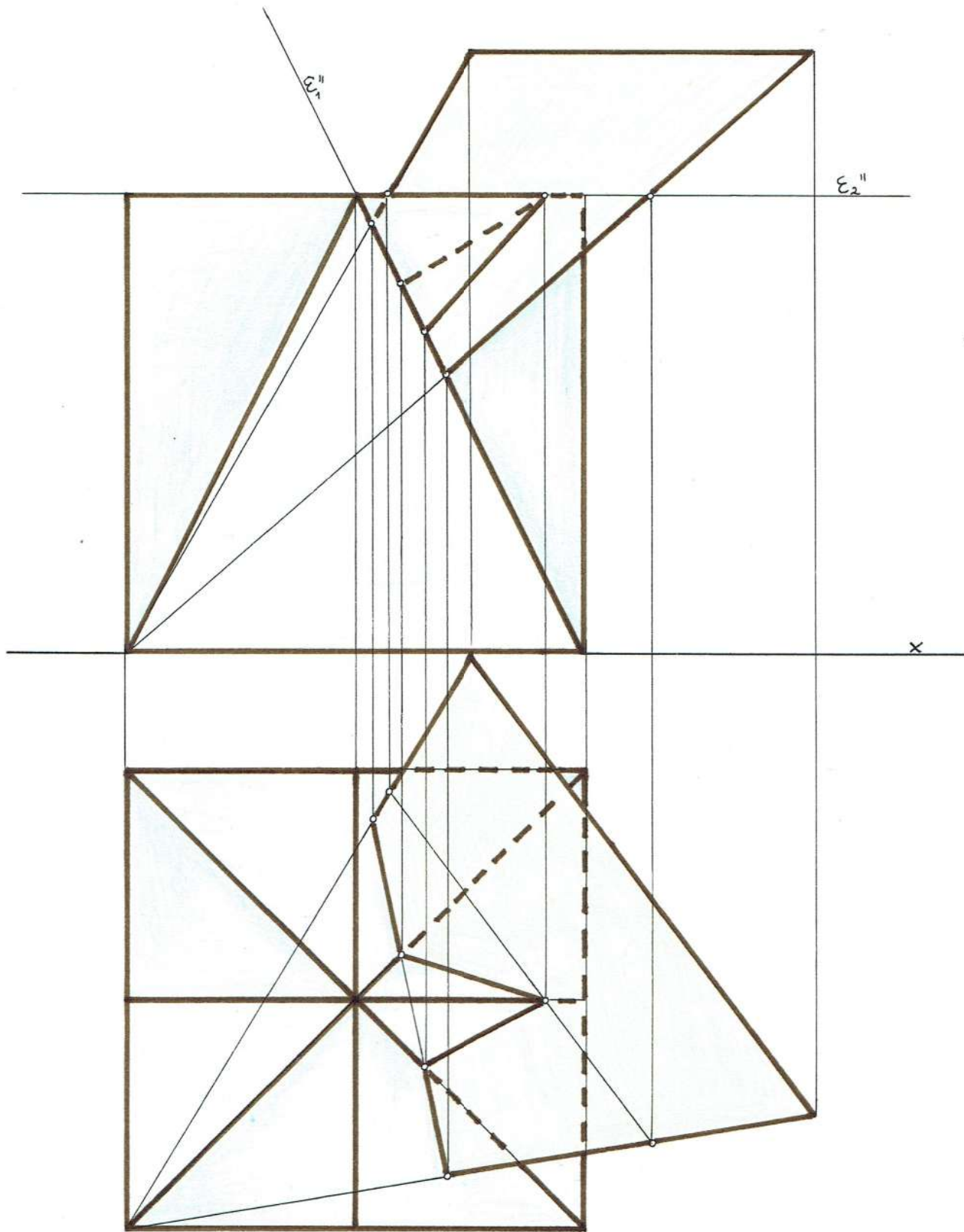

ARKUSZ NR 3

ROK I GR.3 ROK AKADEMICKI 98/99

WYDZIAŁ ARCHITEKTURY

Handwritten signature in blue ink.

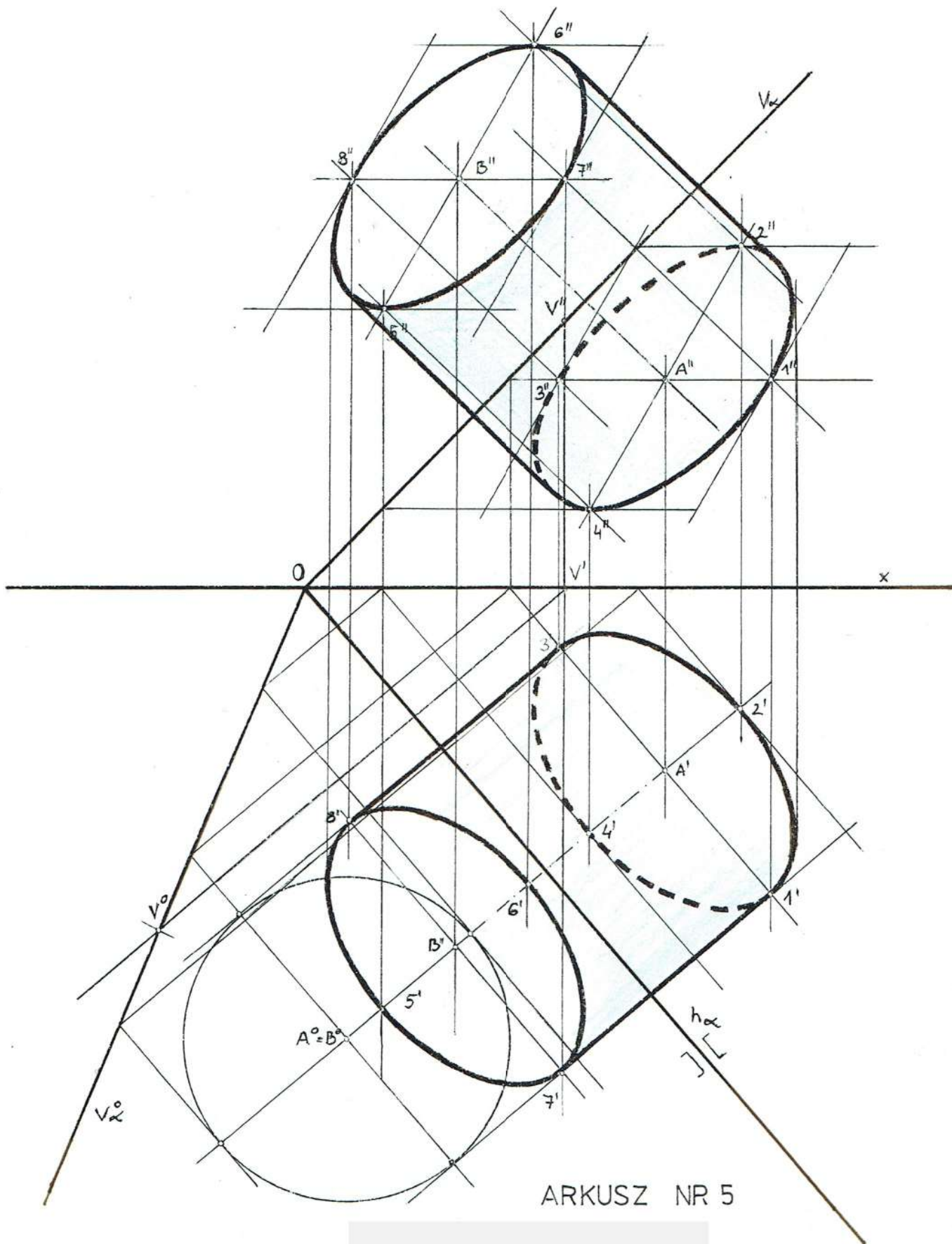

ARKUSZ NR 5

ROK I GR. 3 ROK AKADEMICKI 98/99

WYDZIAŁ ARCHITEKTURY

4.5.98

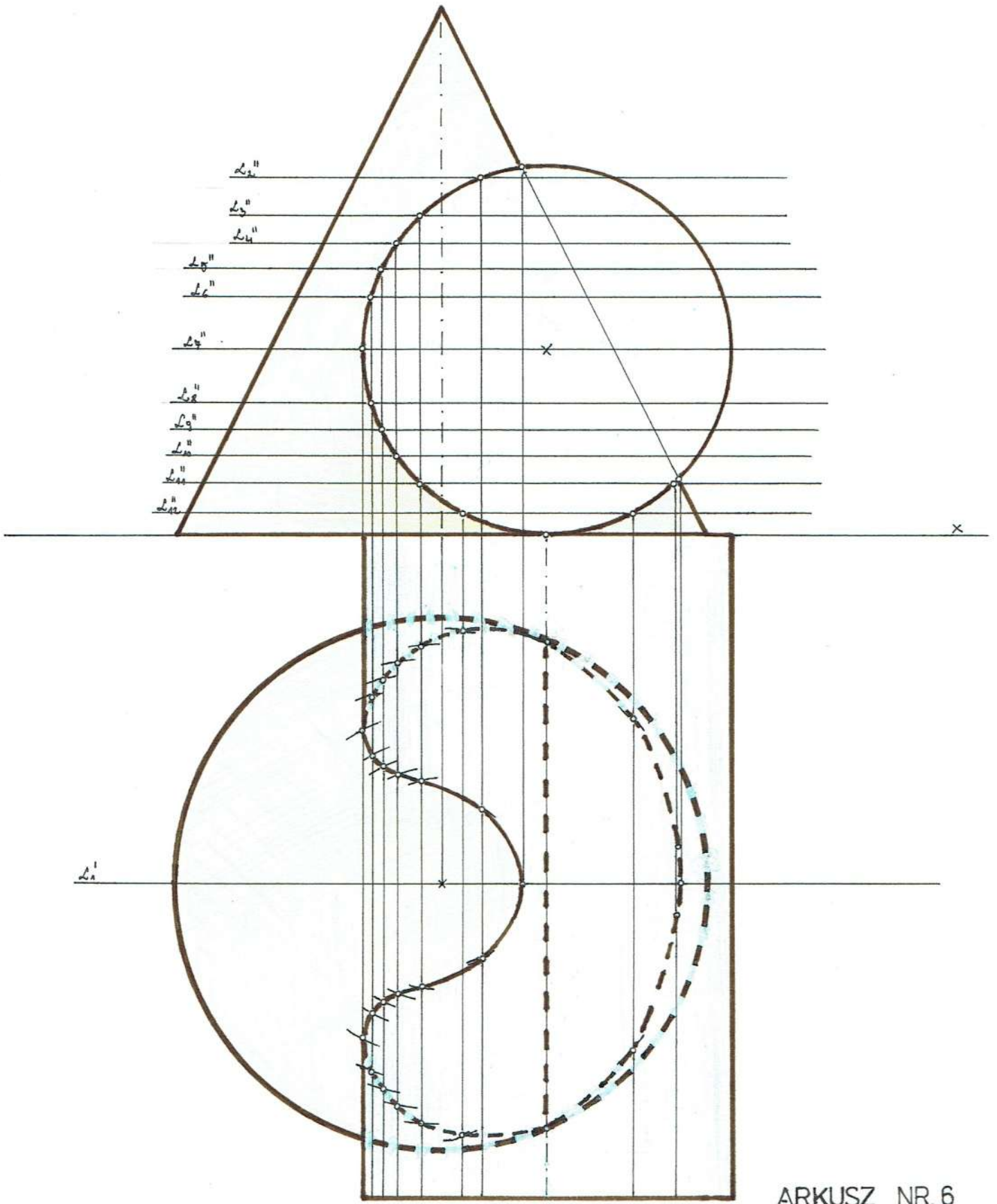

ARKUSZ NR. 6

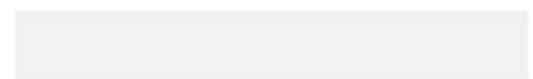

ROK I GR. 3 ROK AKADEM 98/99

5 WYDZIAŁ ARCHITEKTURY

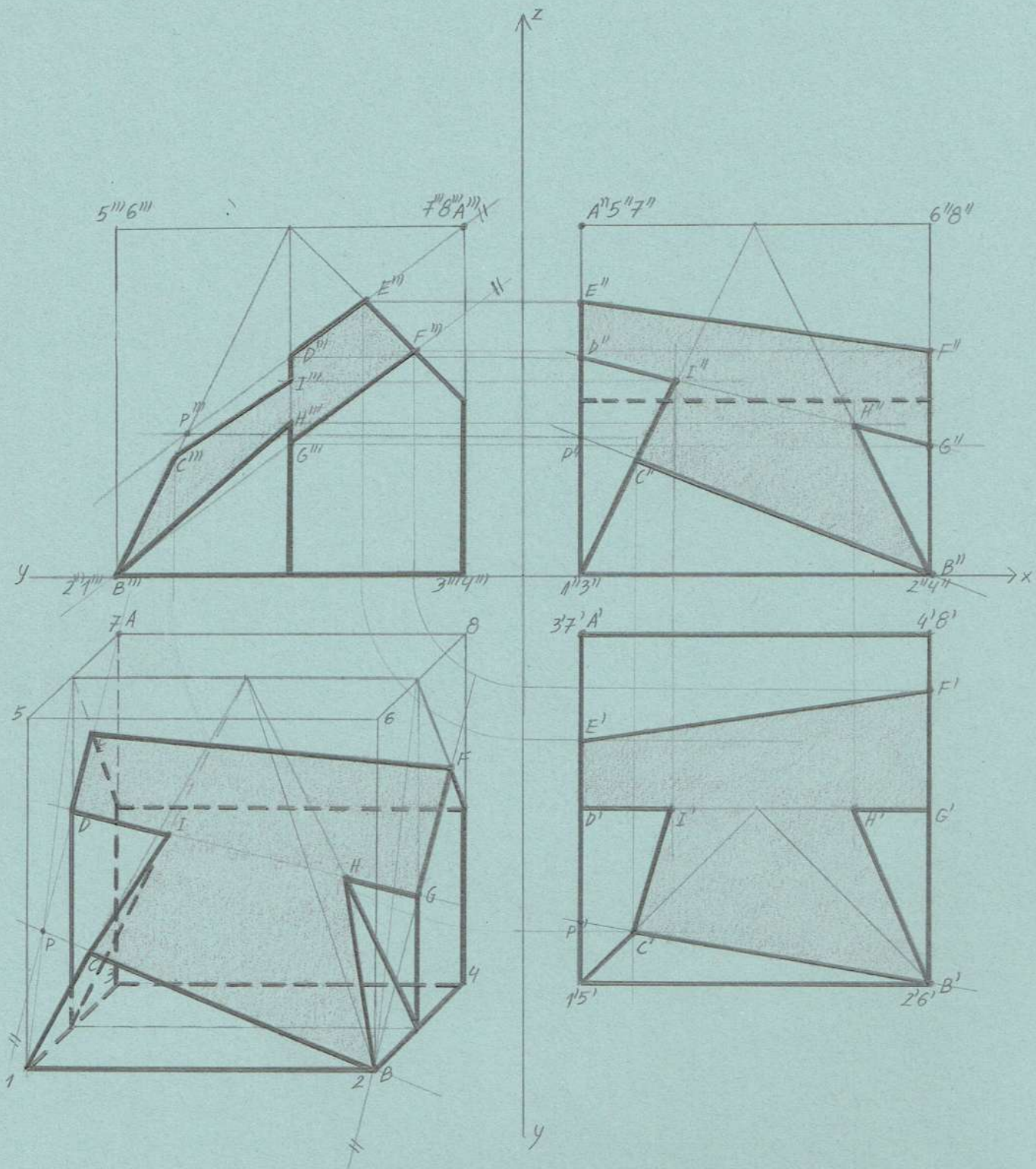

10/10 2024

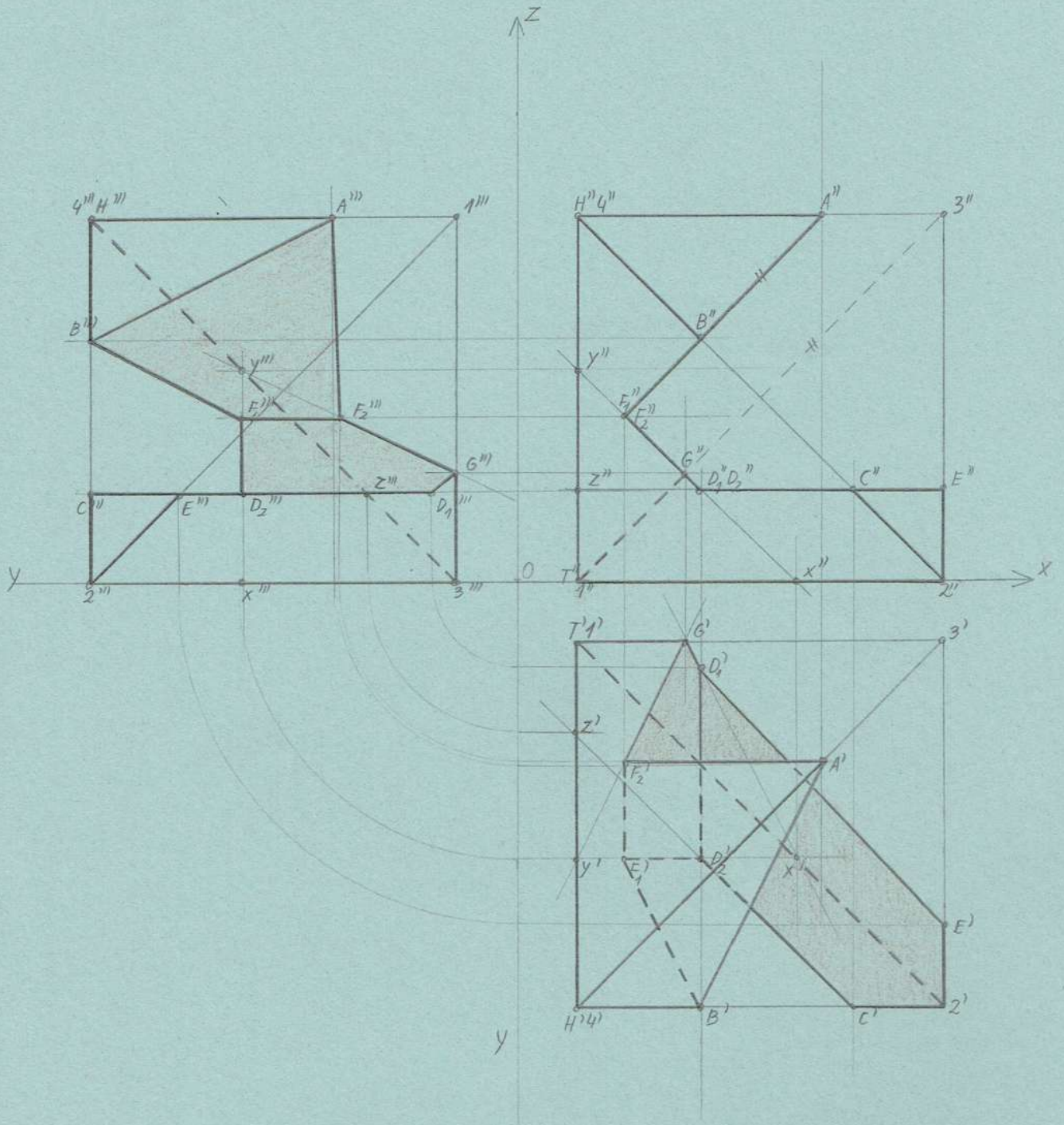

10/10/24



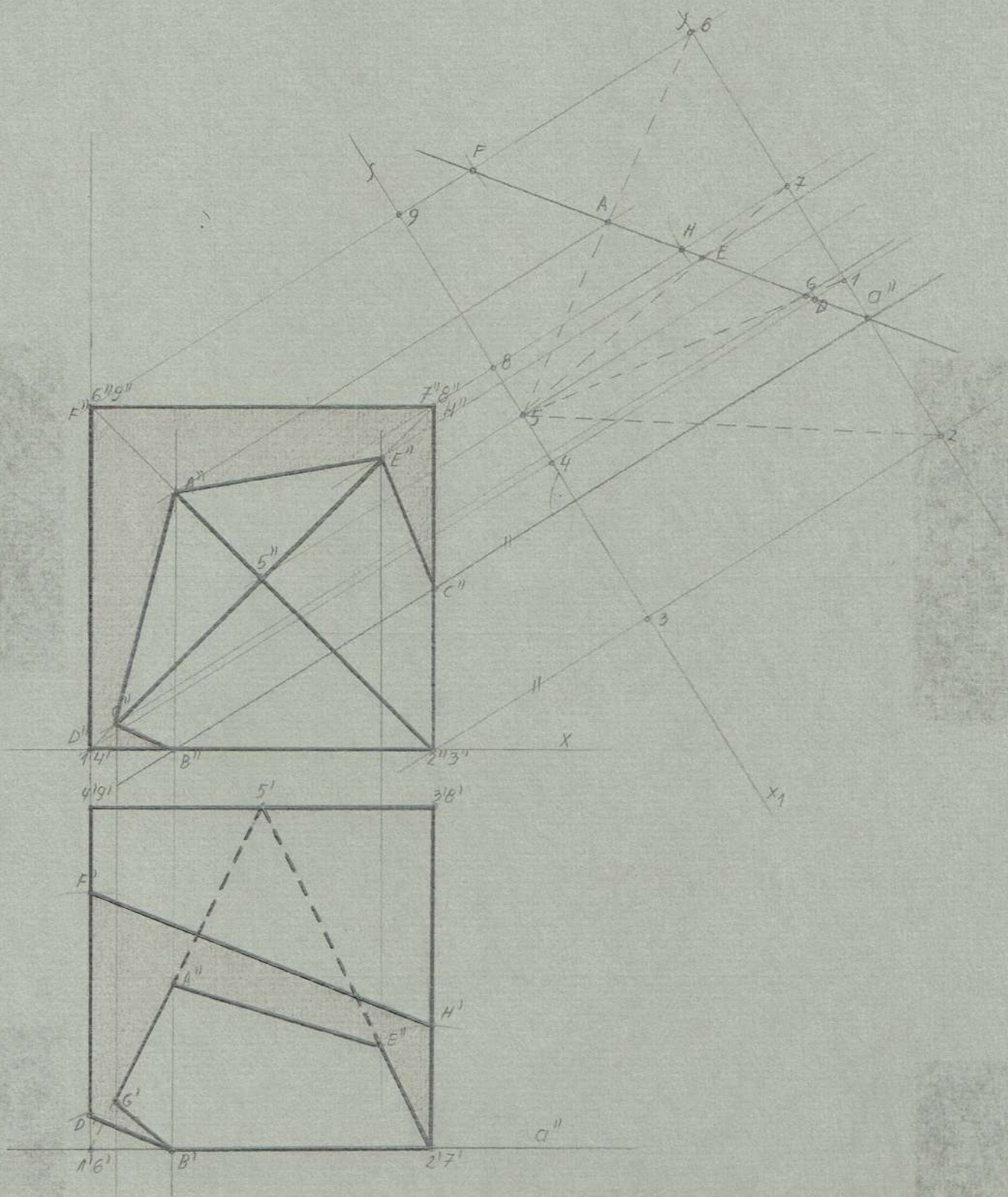

9,5/10 pec

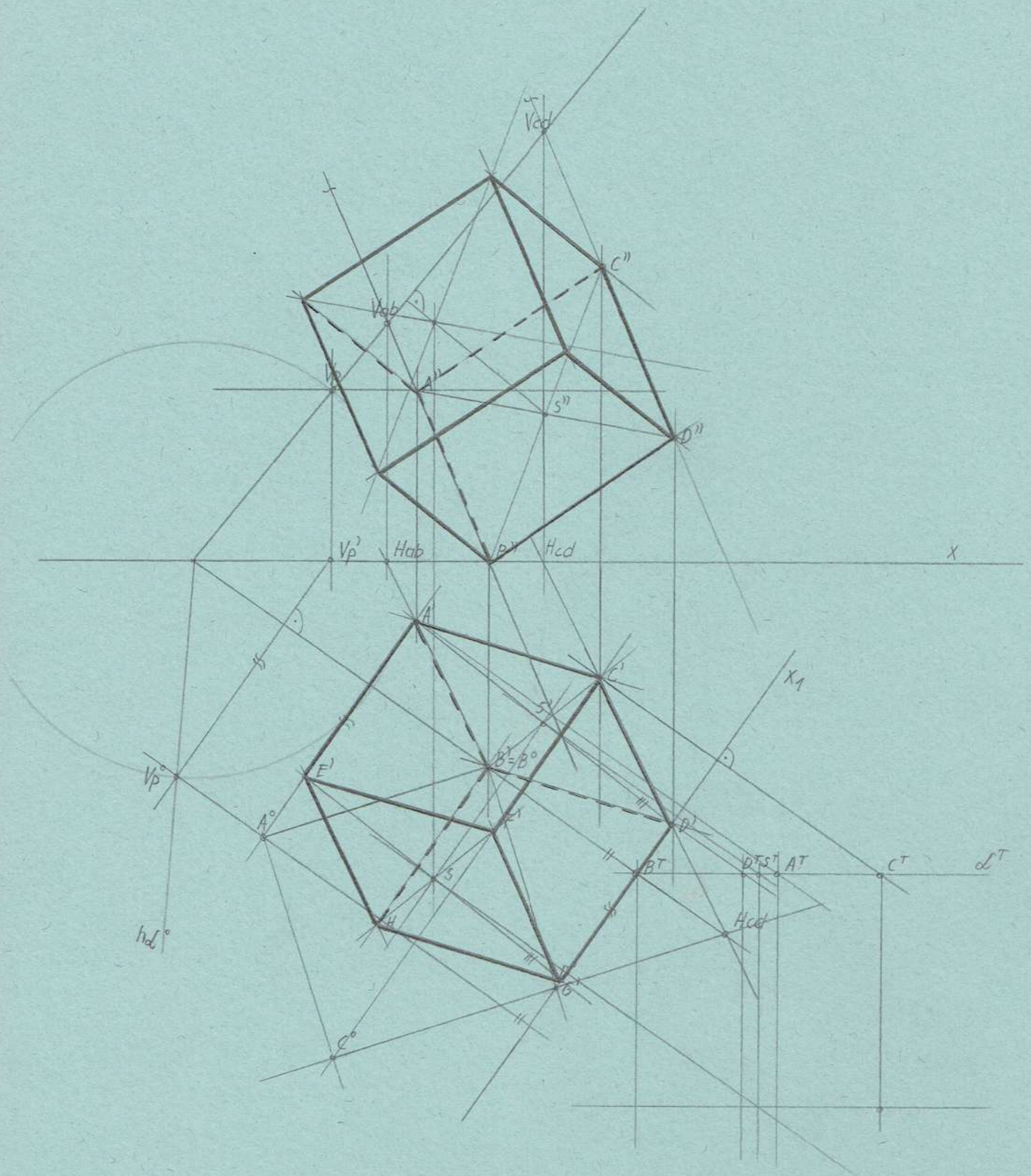

① 9/10/20



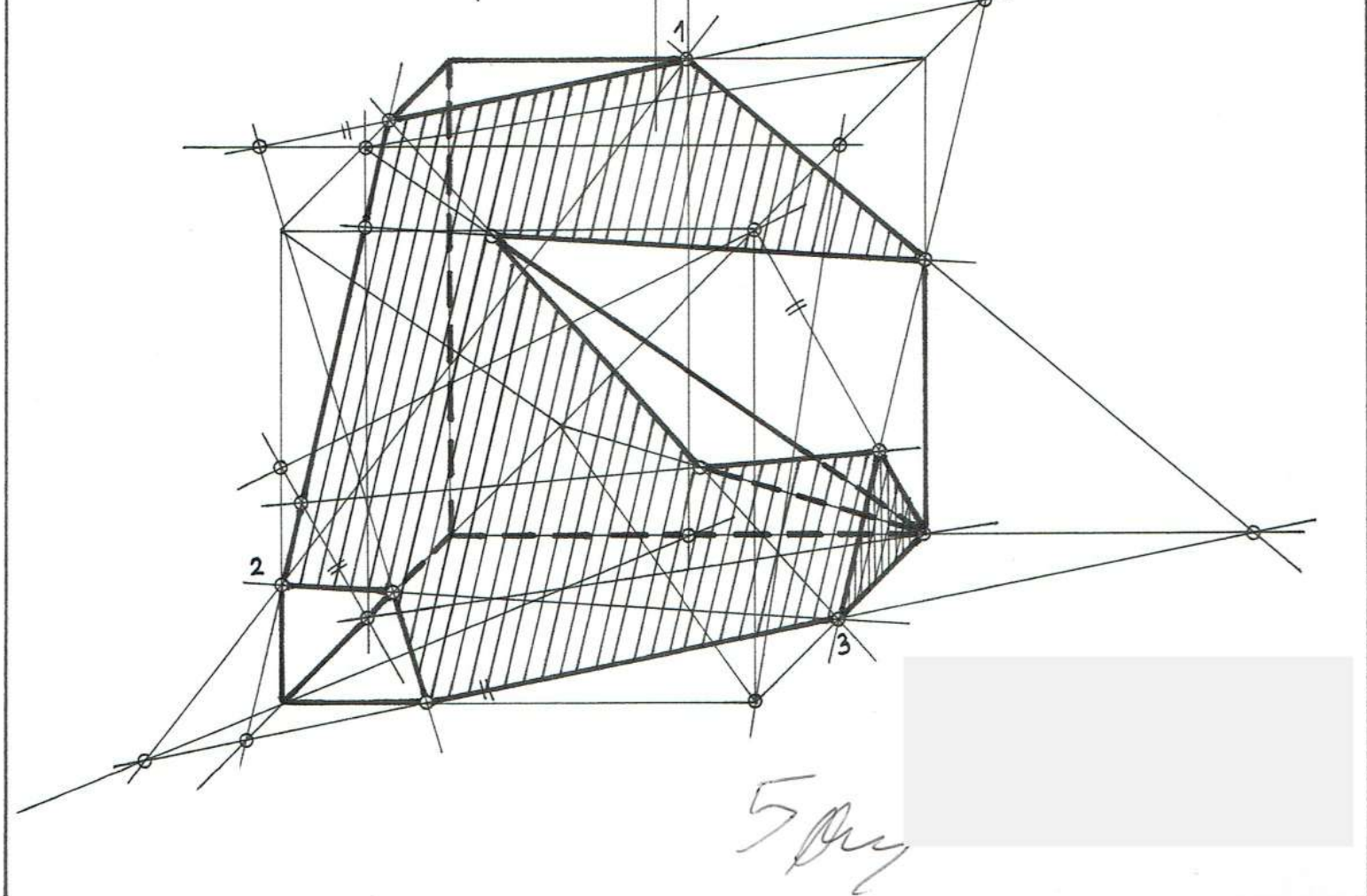
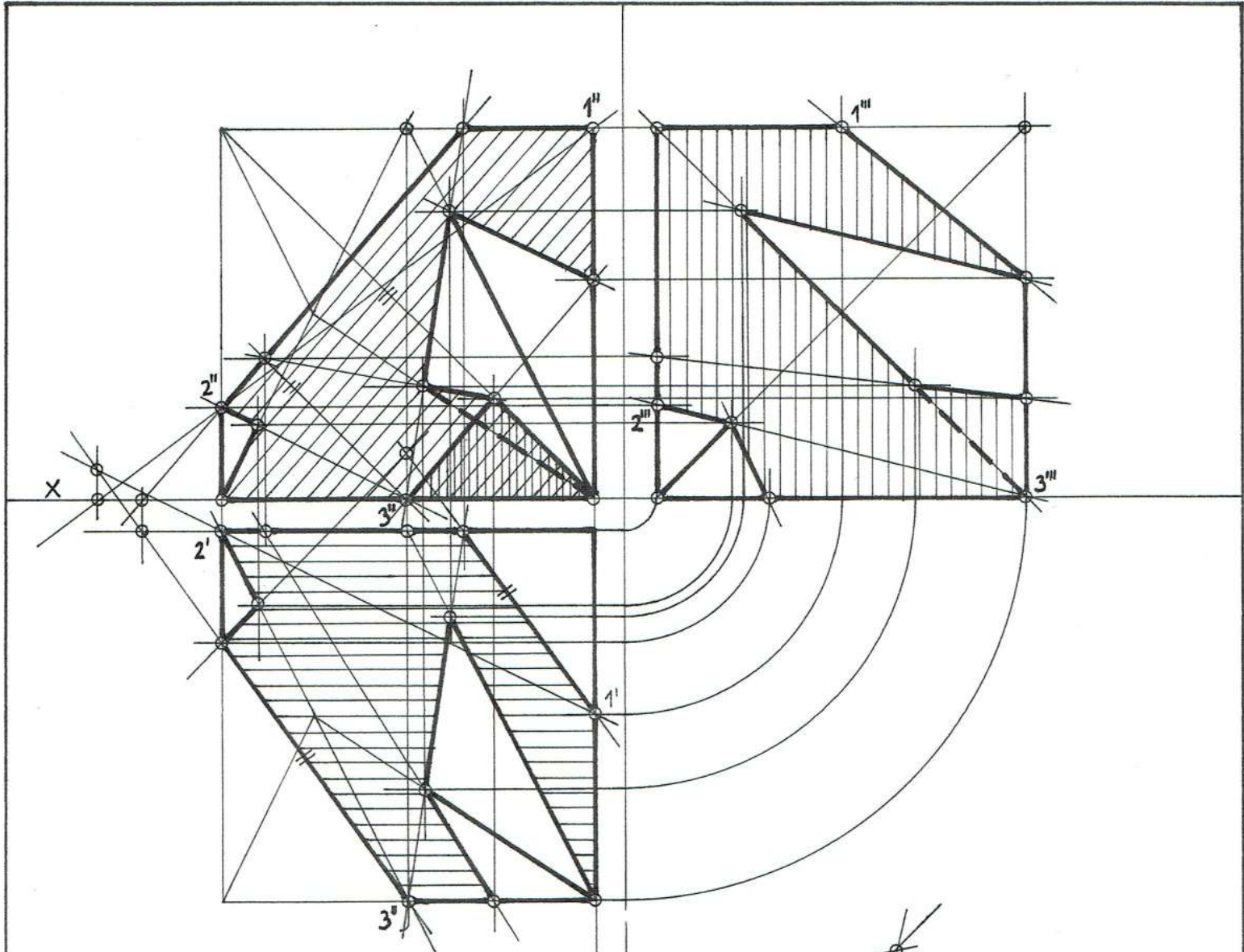

5 Aug

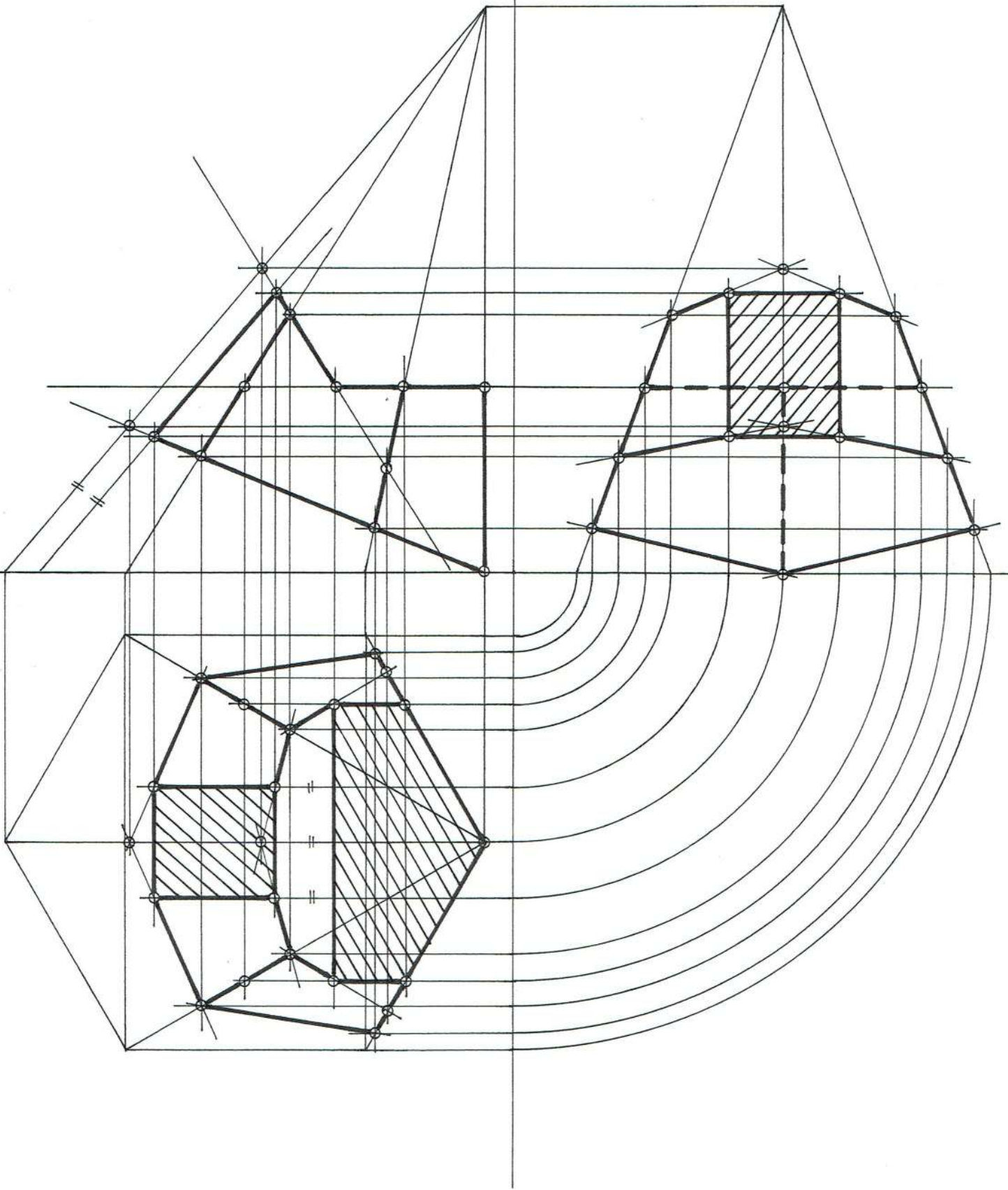

4.5/23

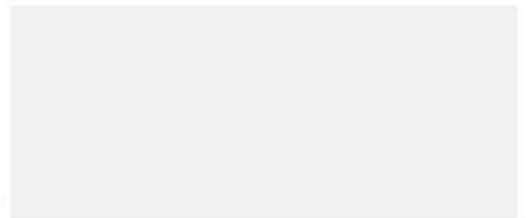

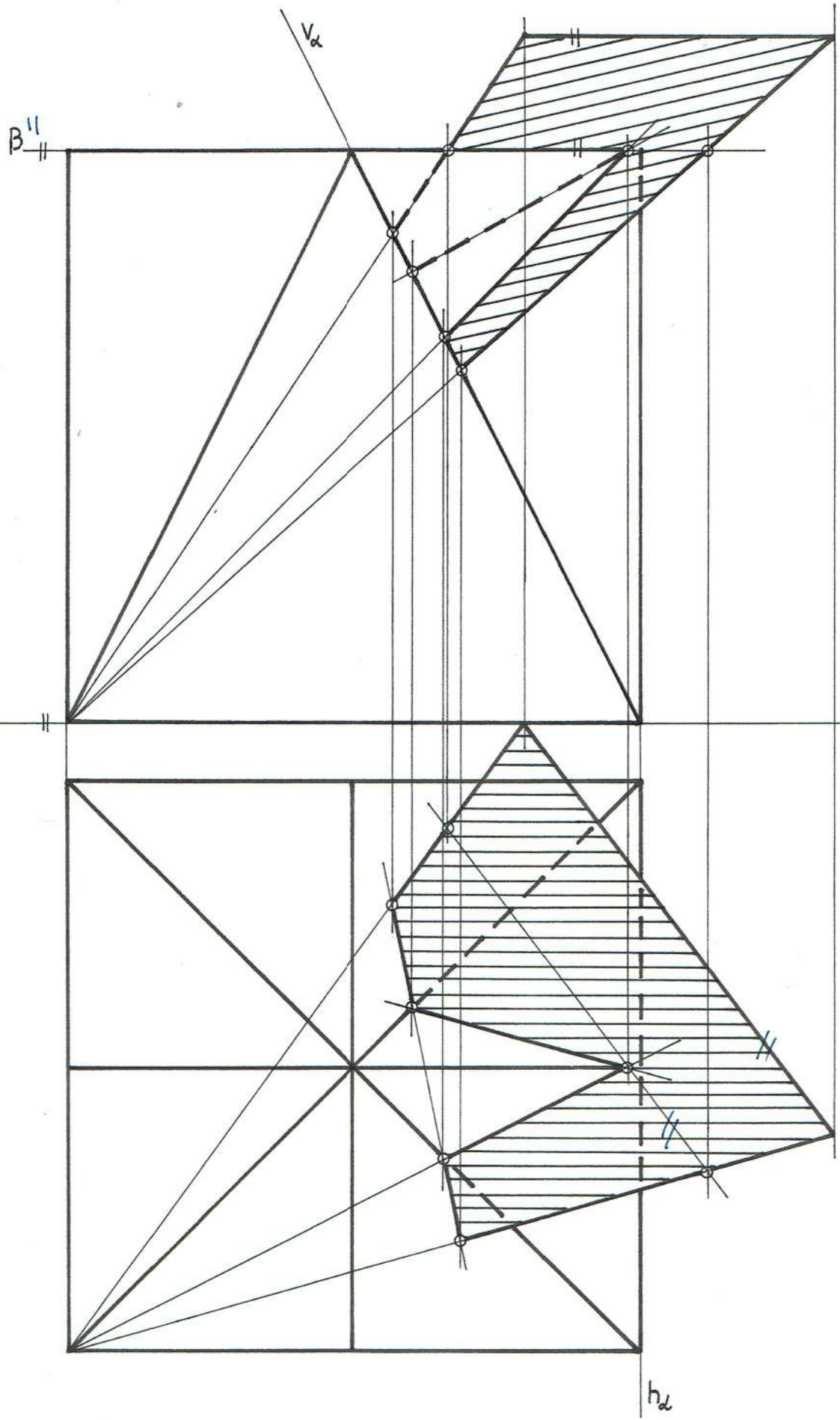

4.5 Aug

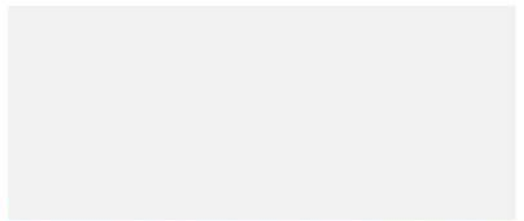

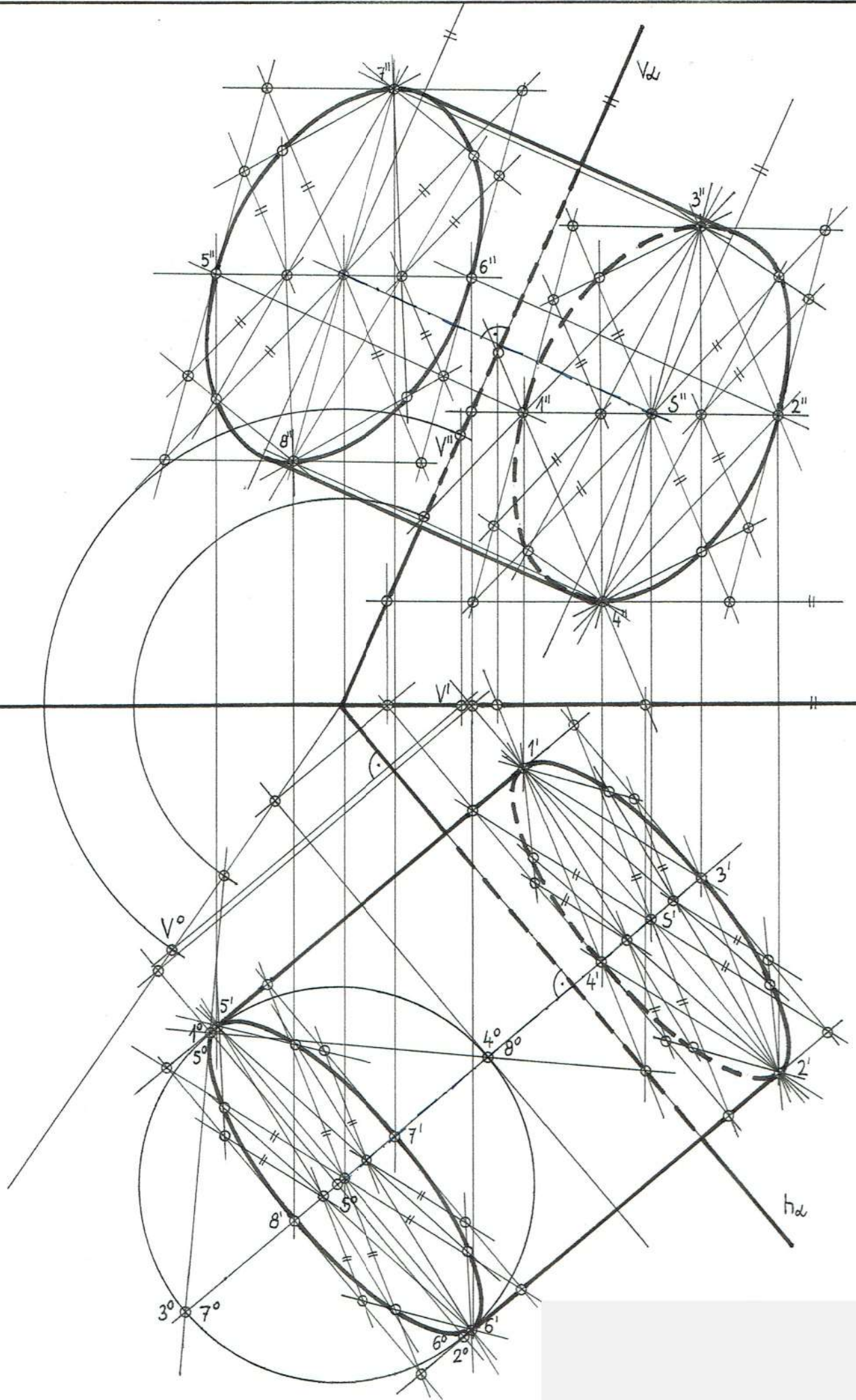

X

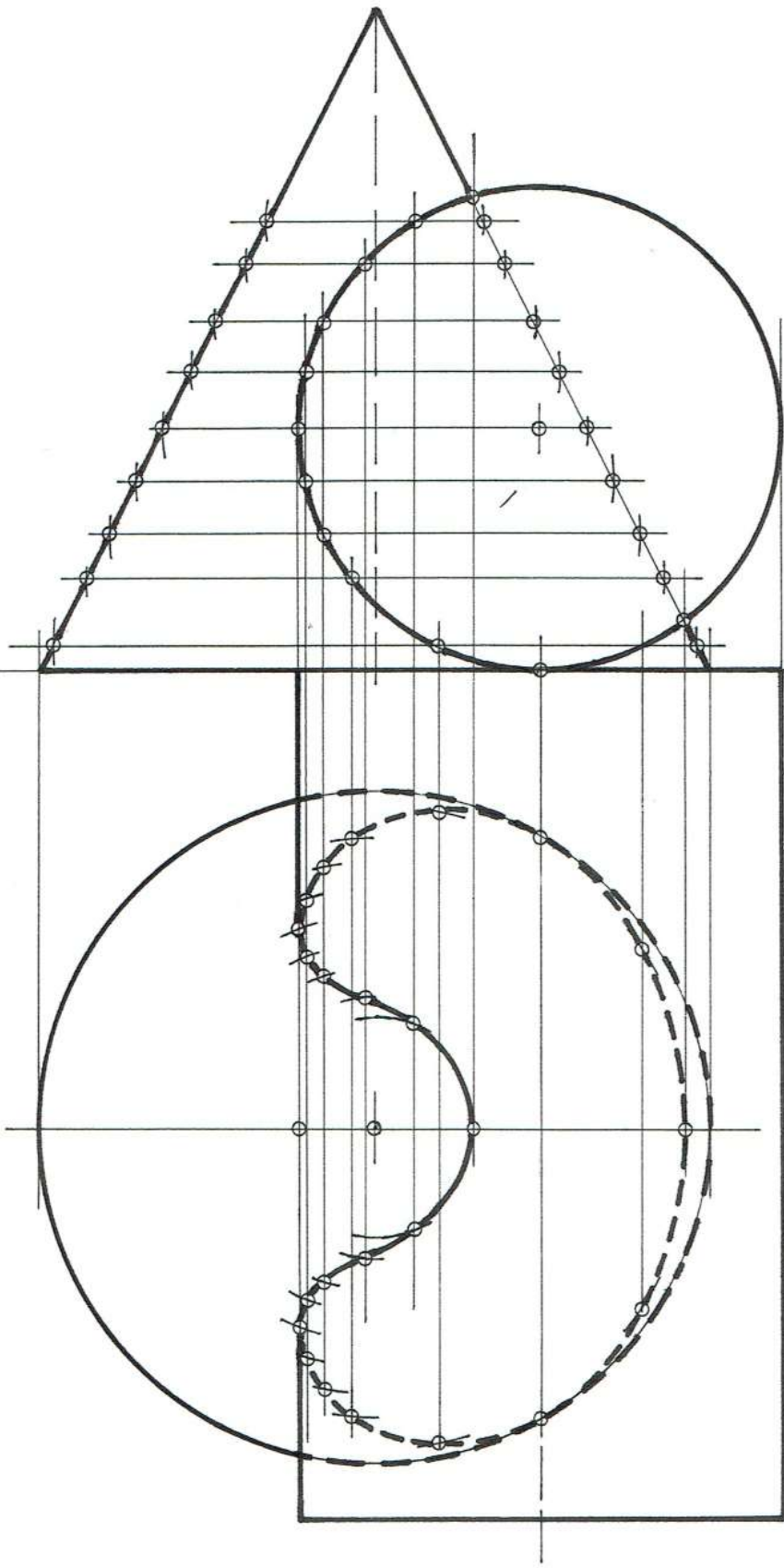

5

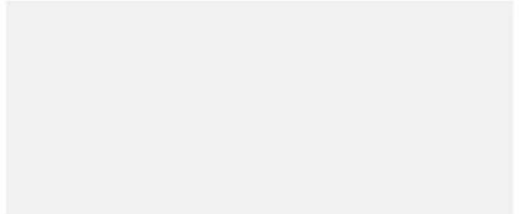

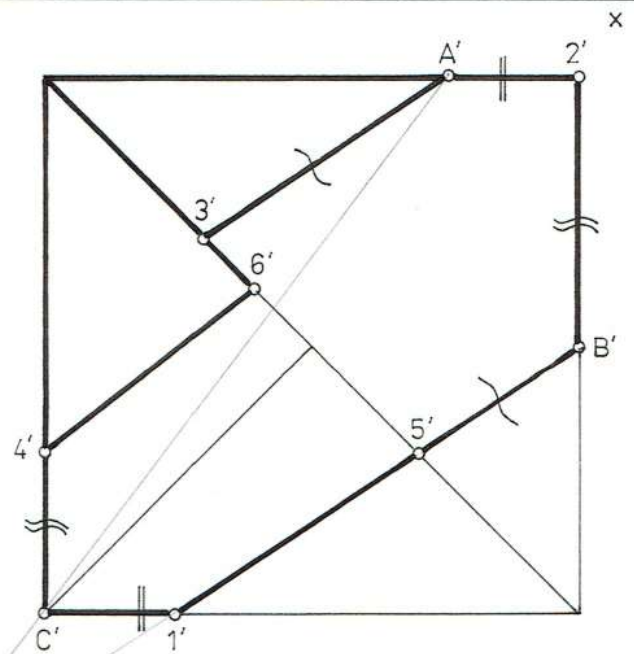
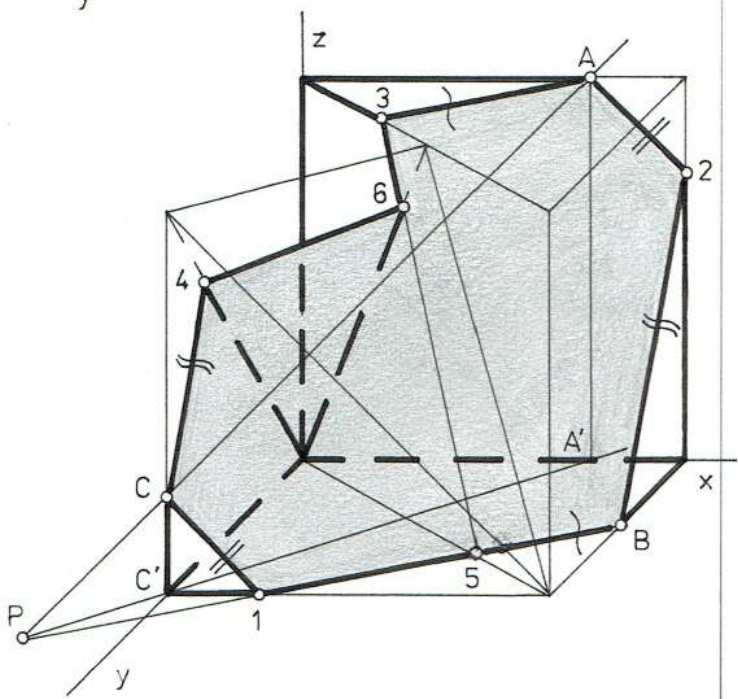
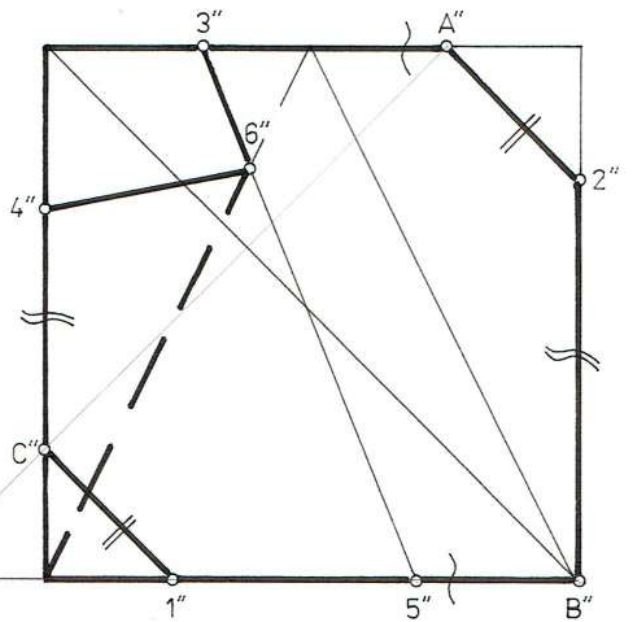
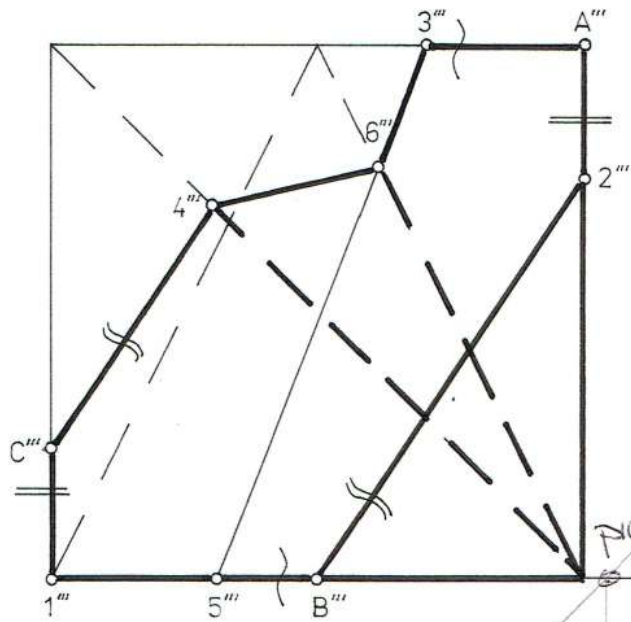

7-04

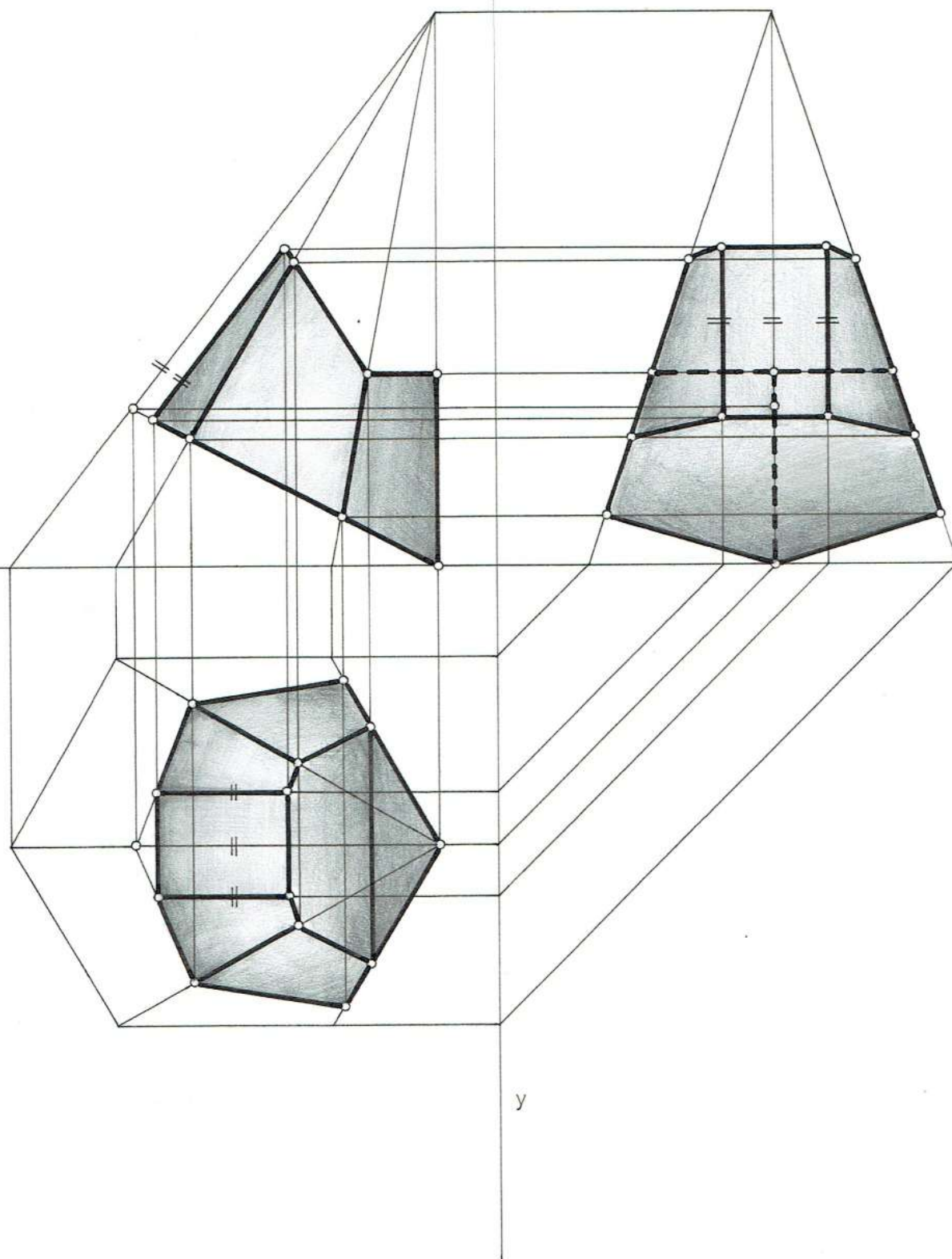

4.5 puz

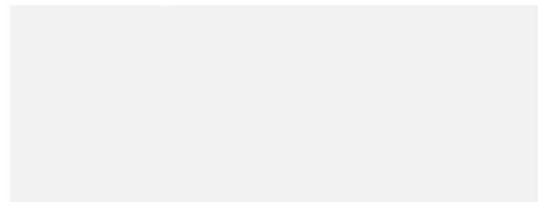

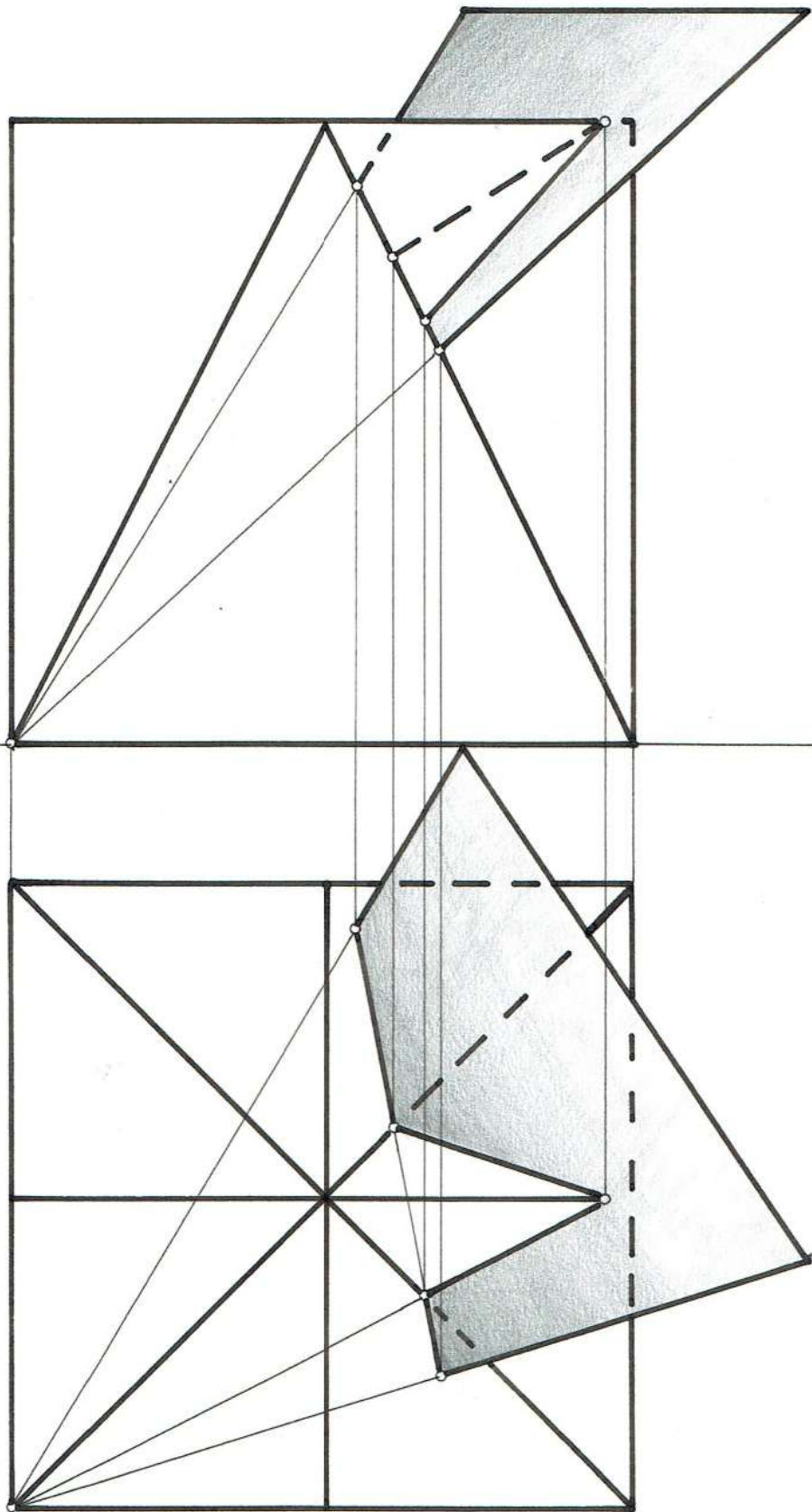

5-2017

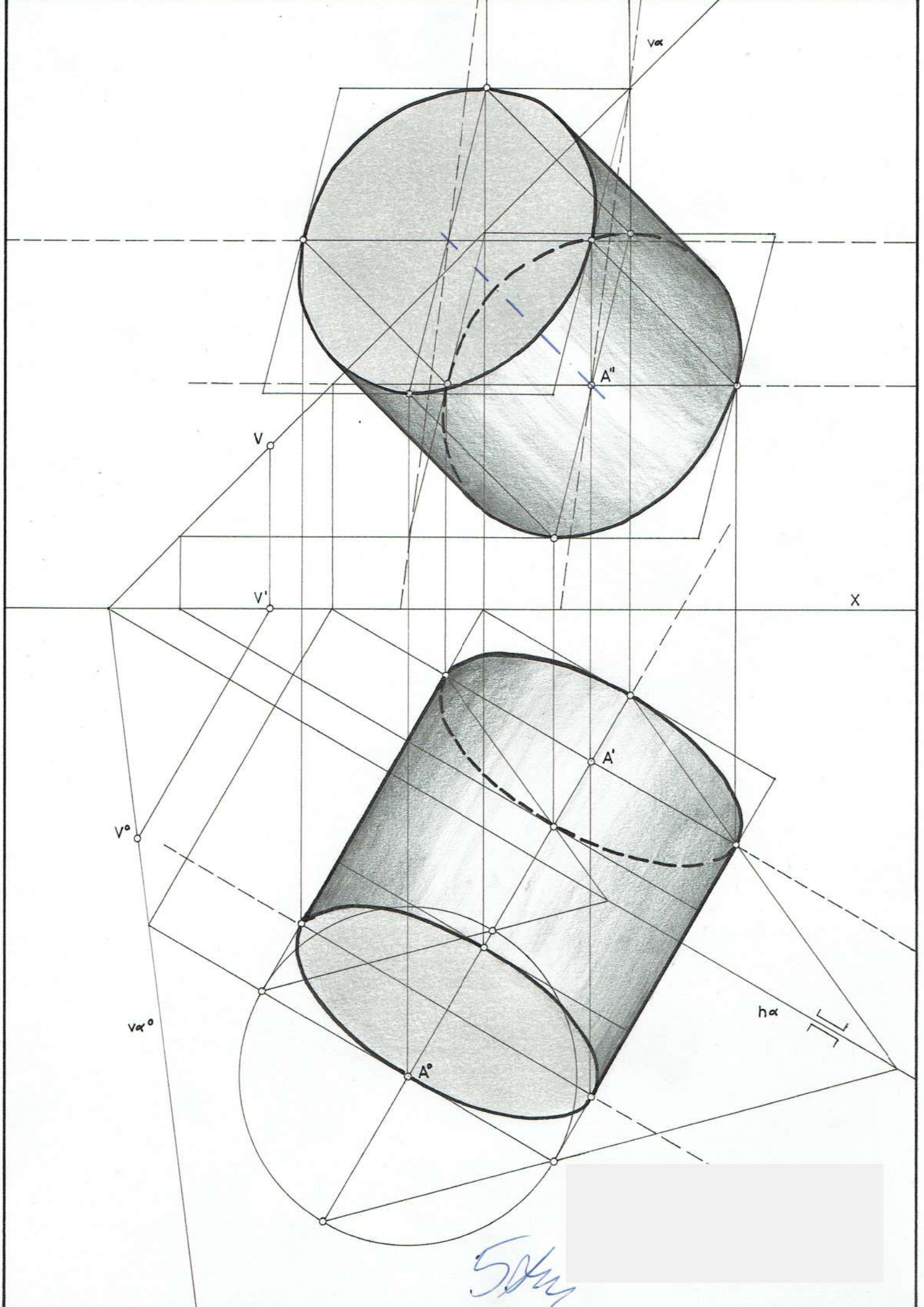

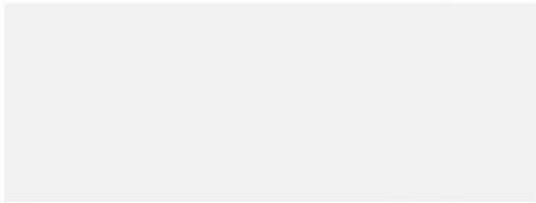
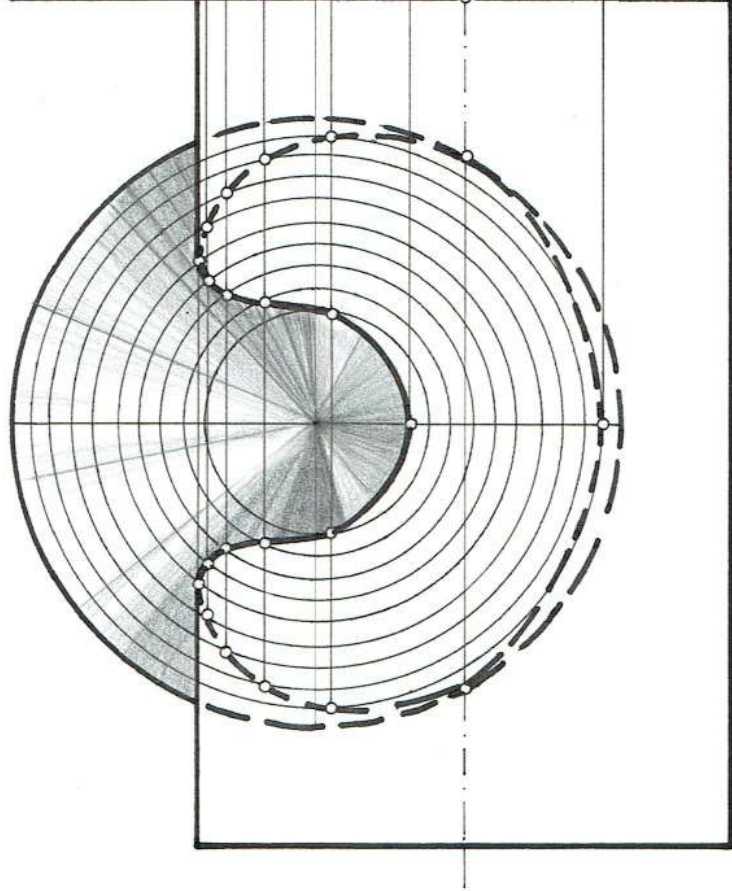
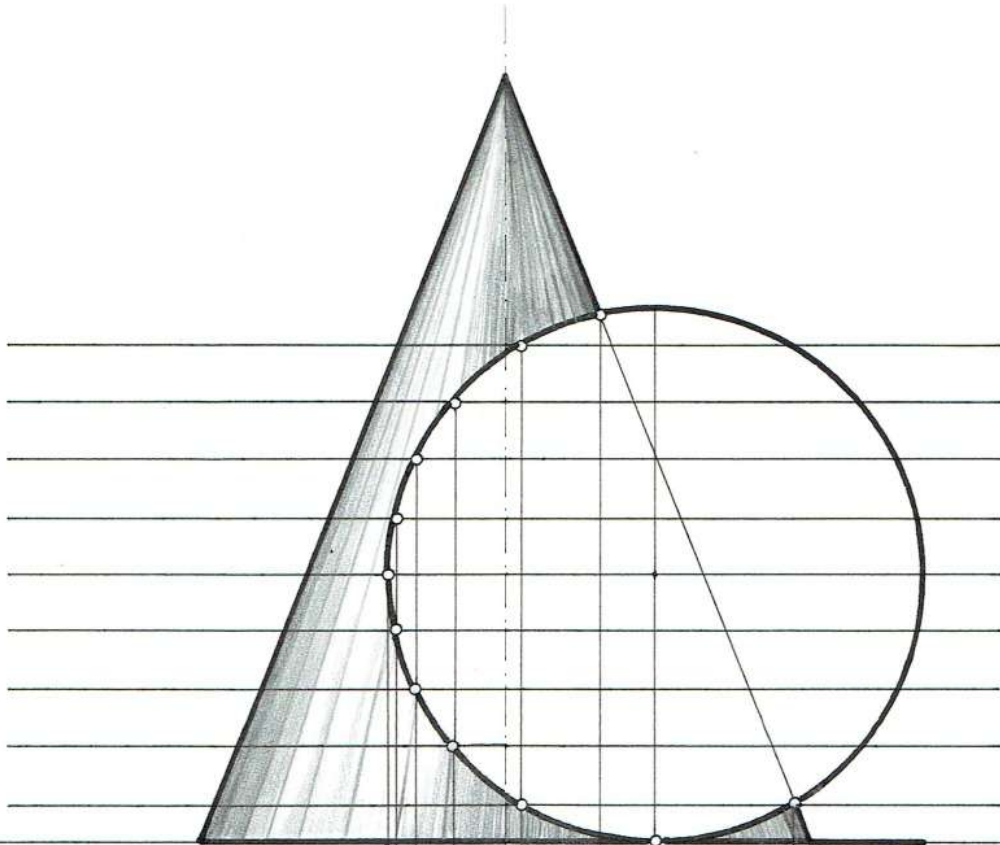

5

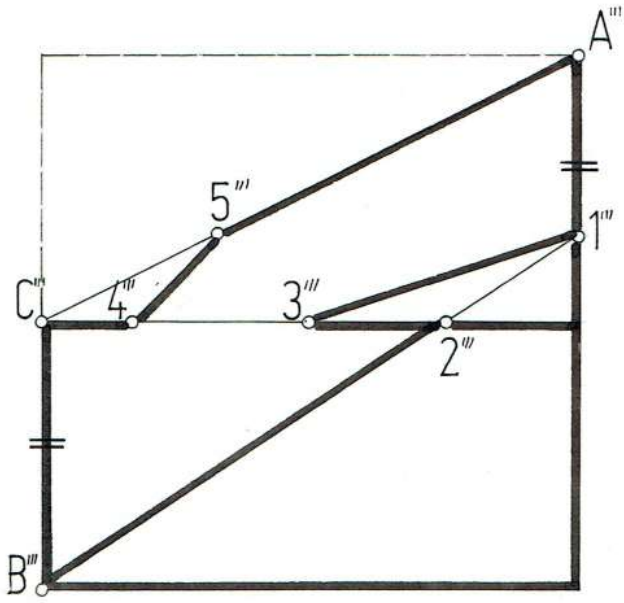

Z

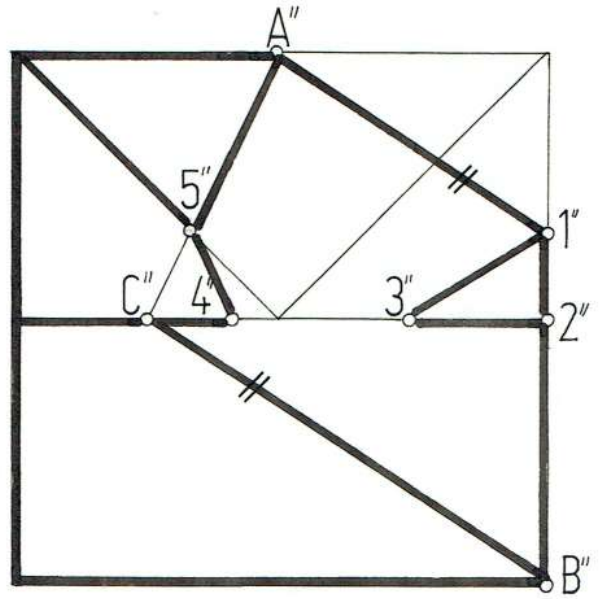

Y

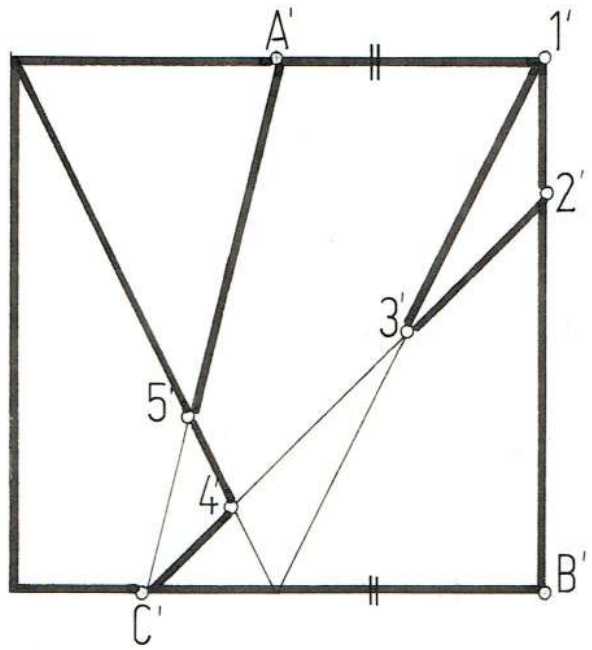
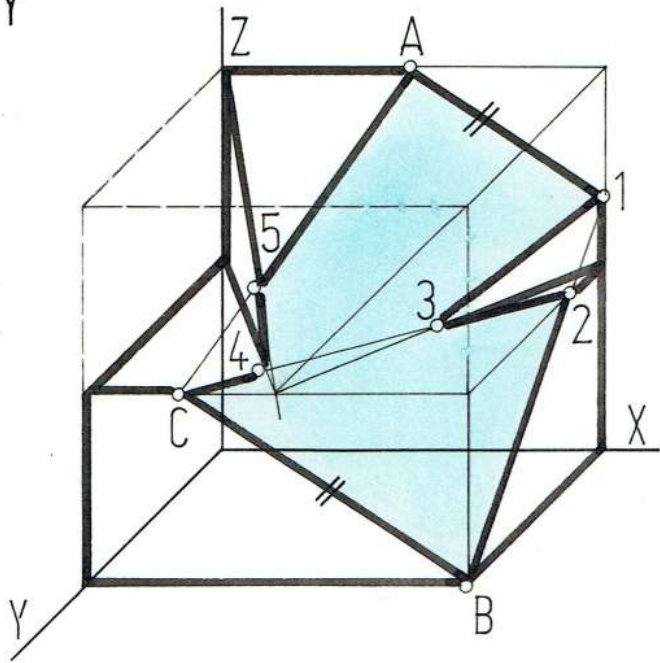

Y

5 Aug

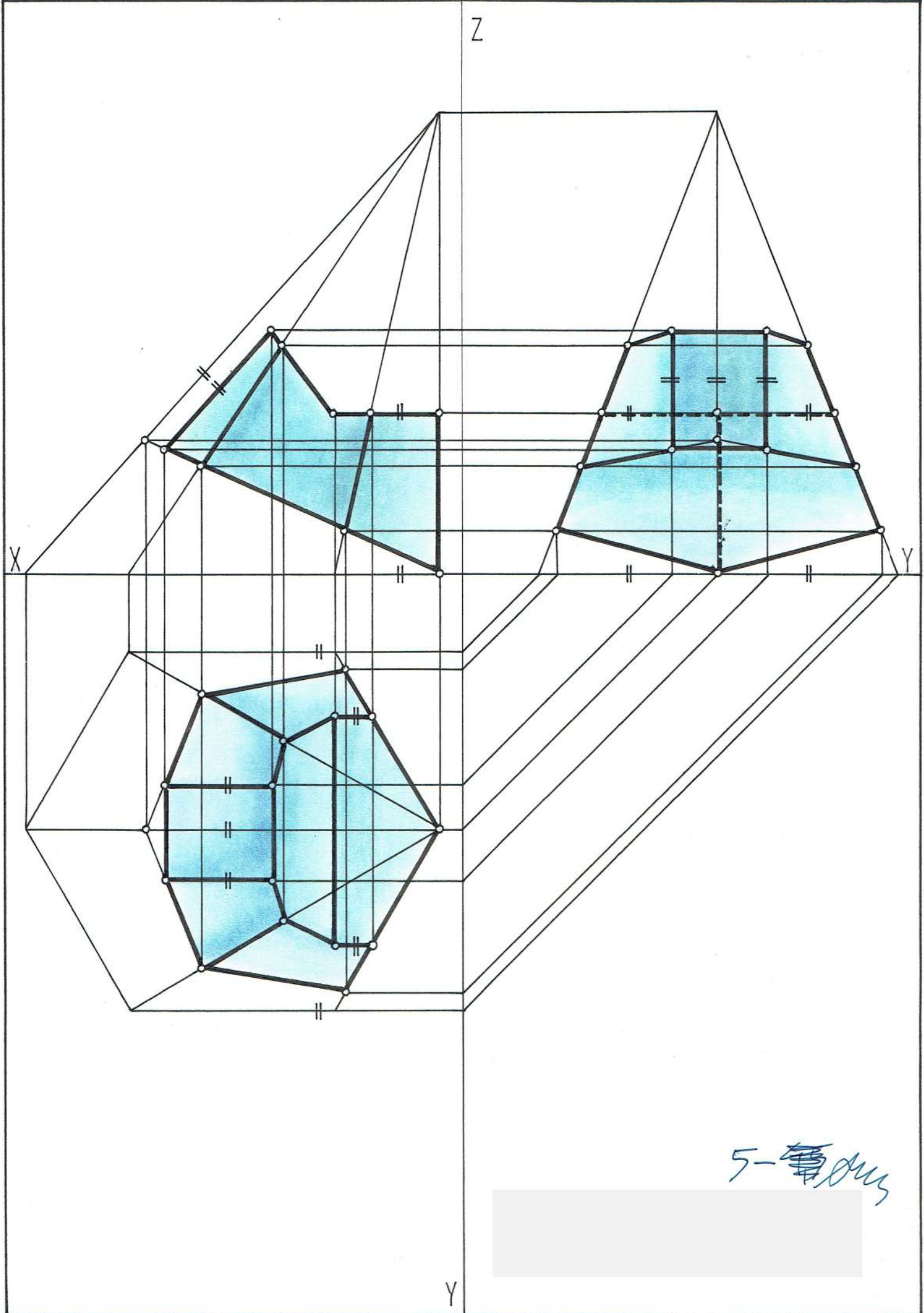

5-第0113



Y

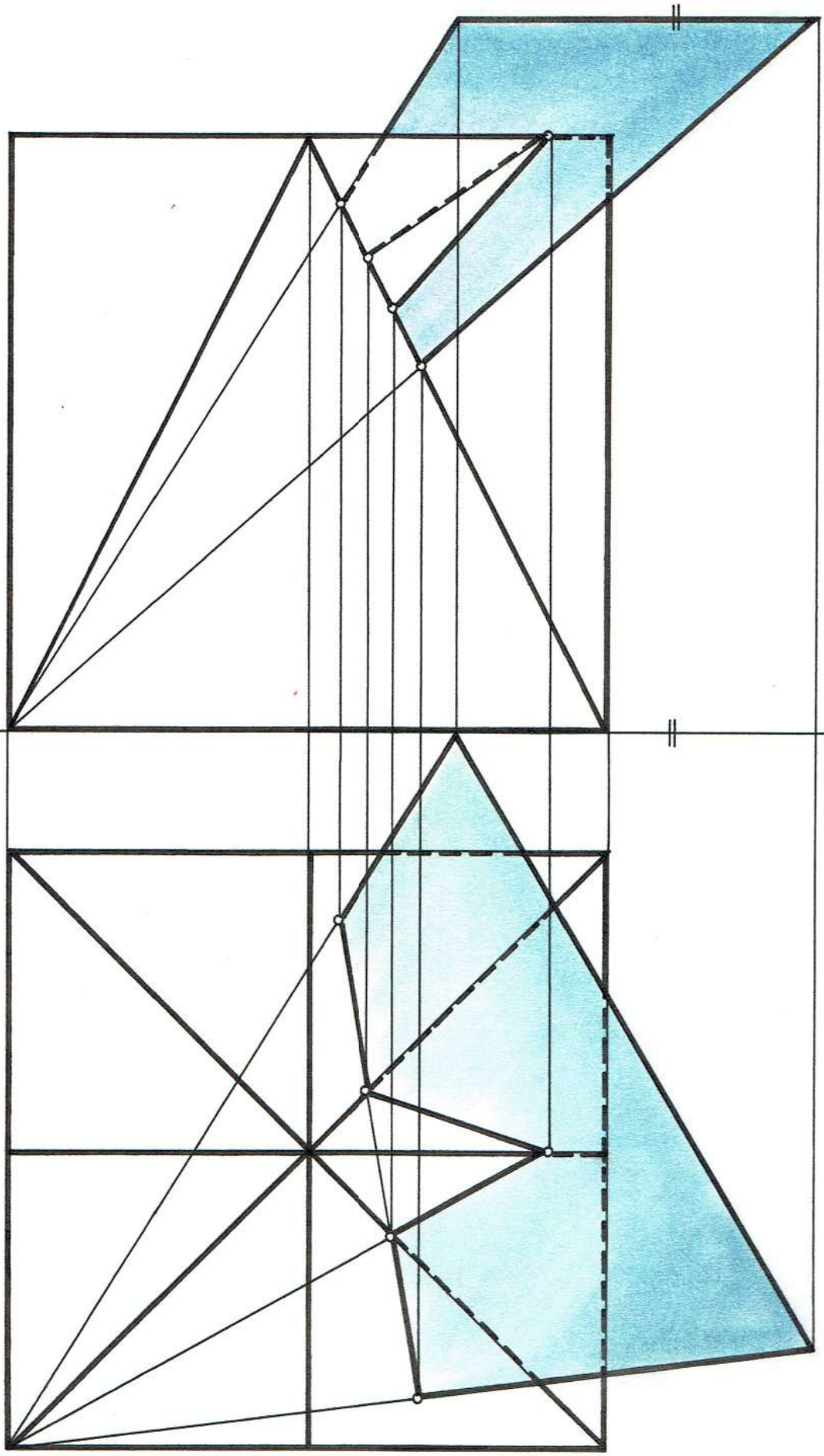

X

II

5 Aug

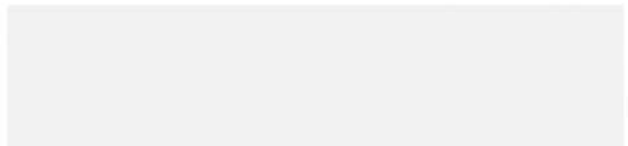

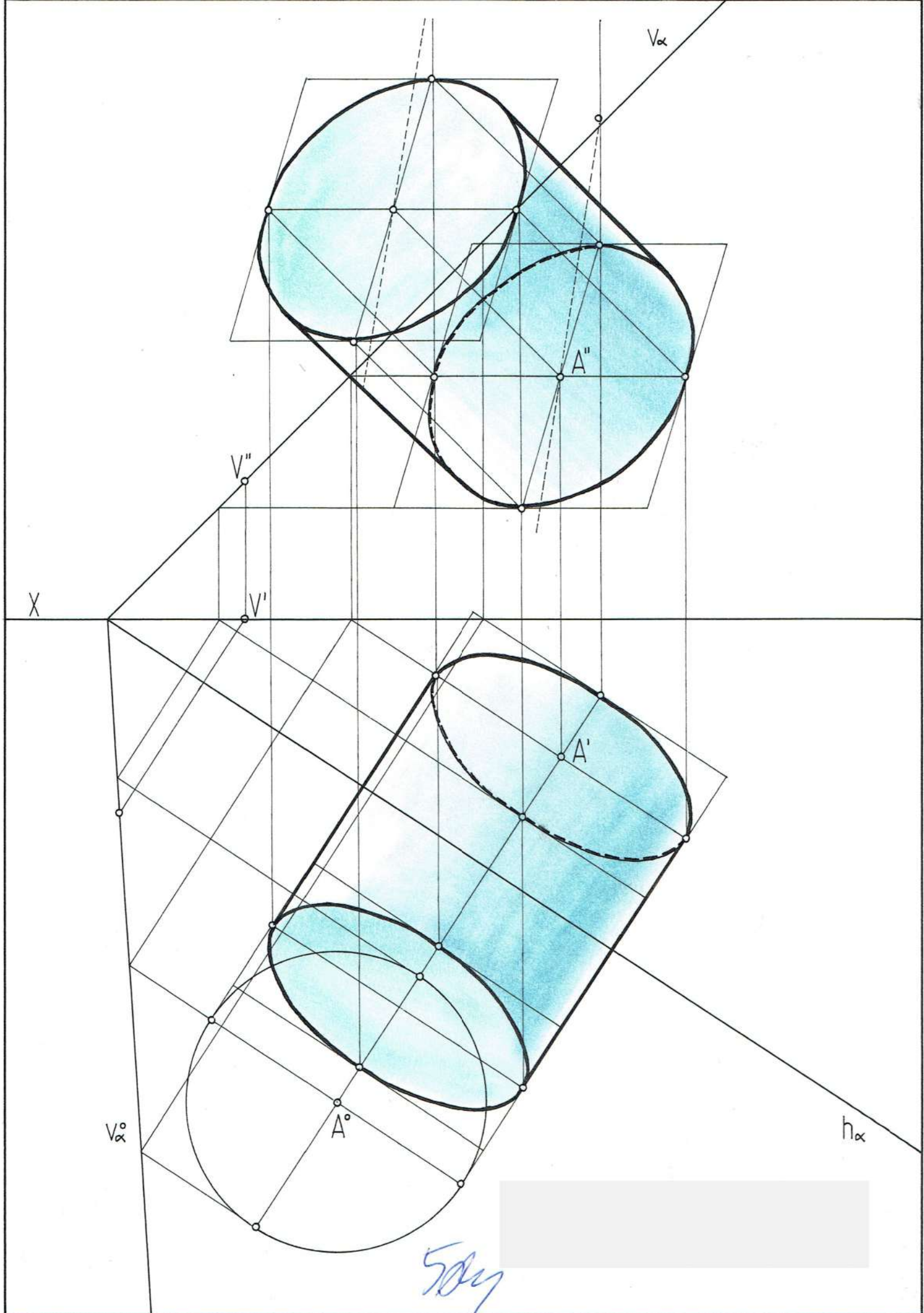

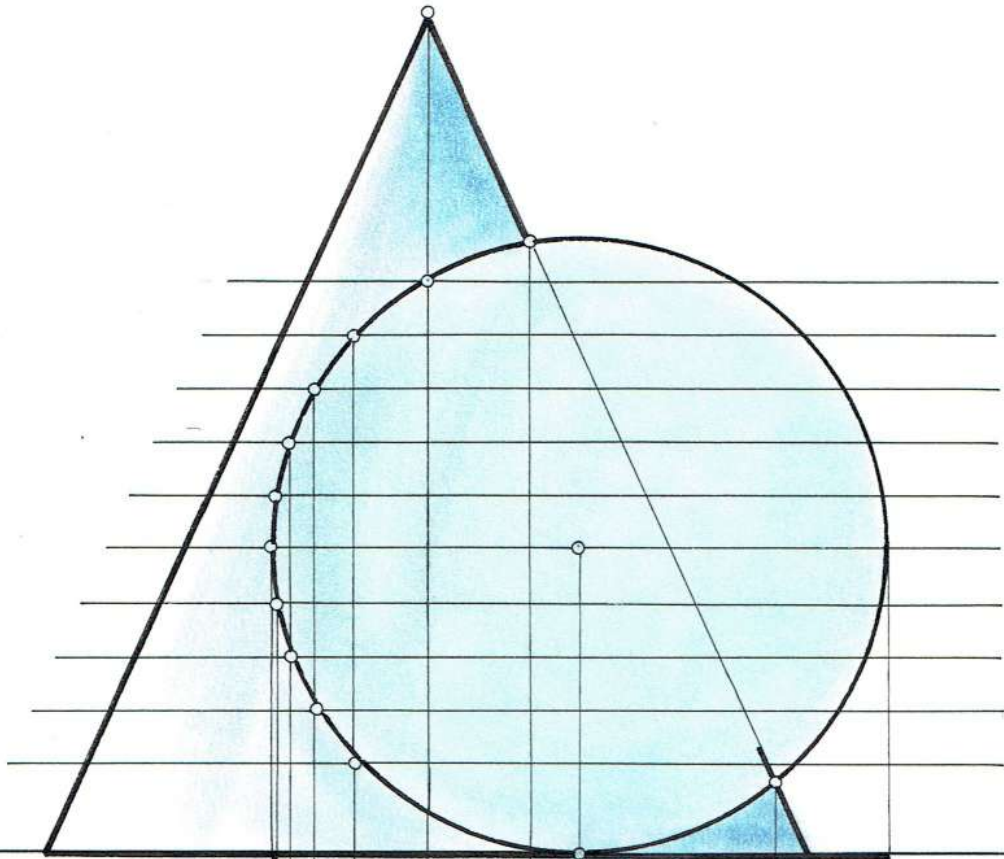

X

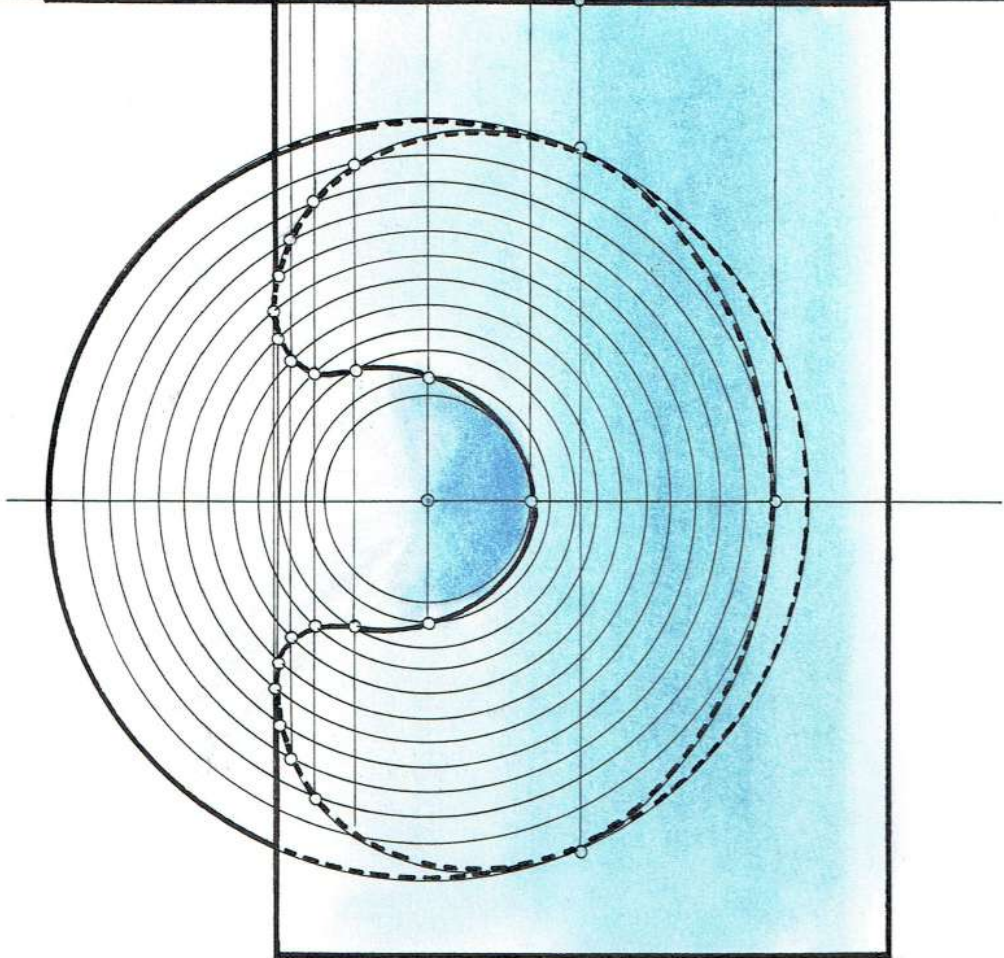

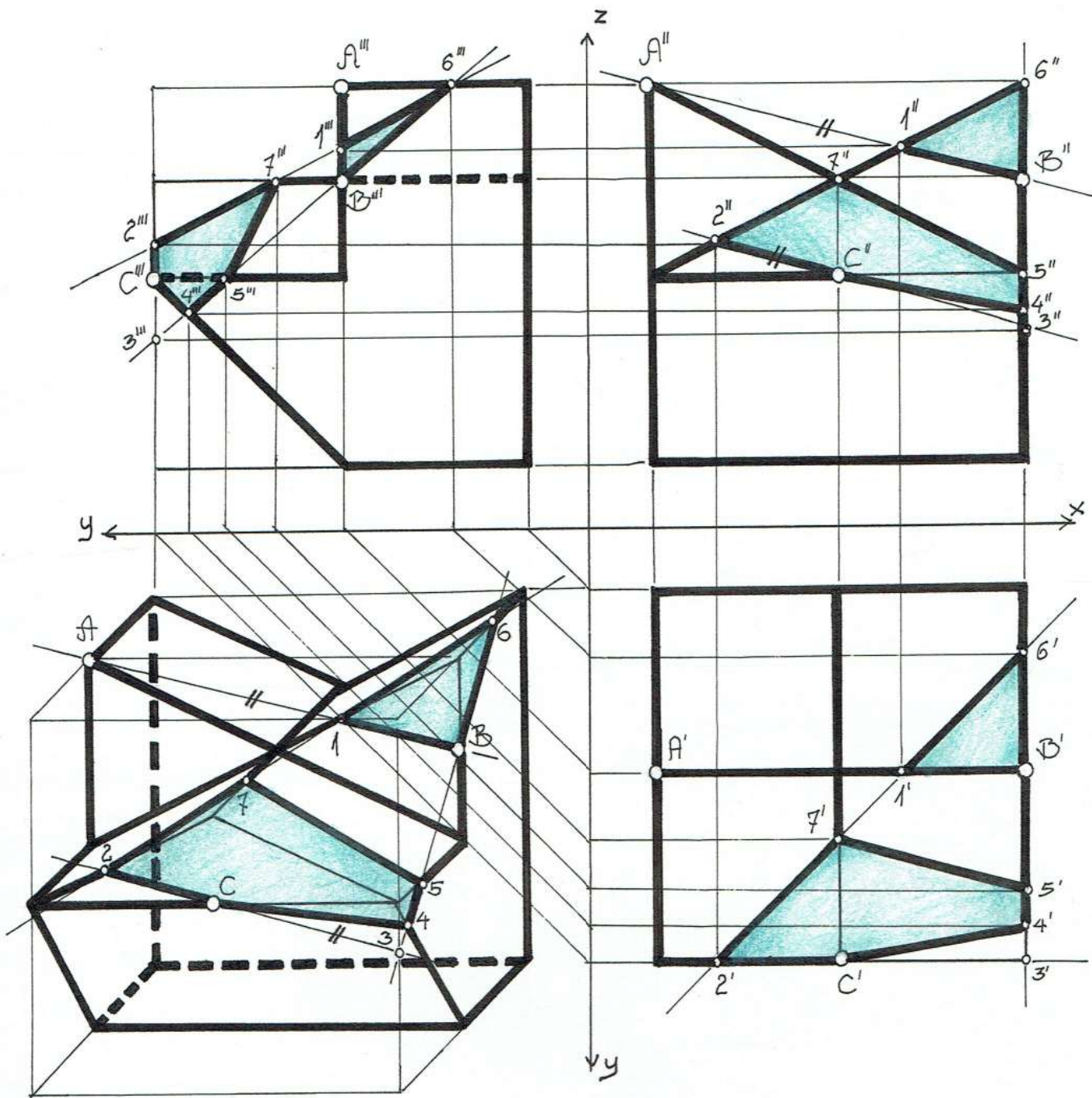

5 maj

Wydział Architektury
 Rok 1. Gr. 3 R.A 98/99
 Arkusz Nr. 1.

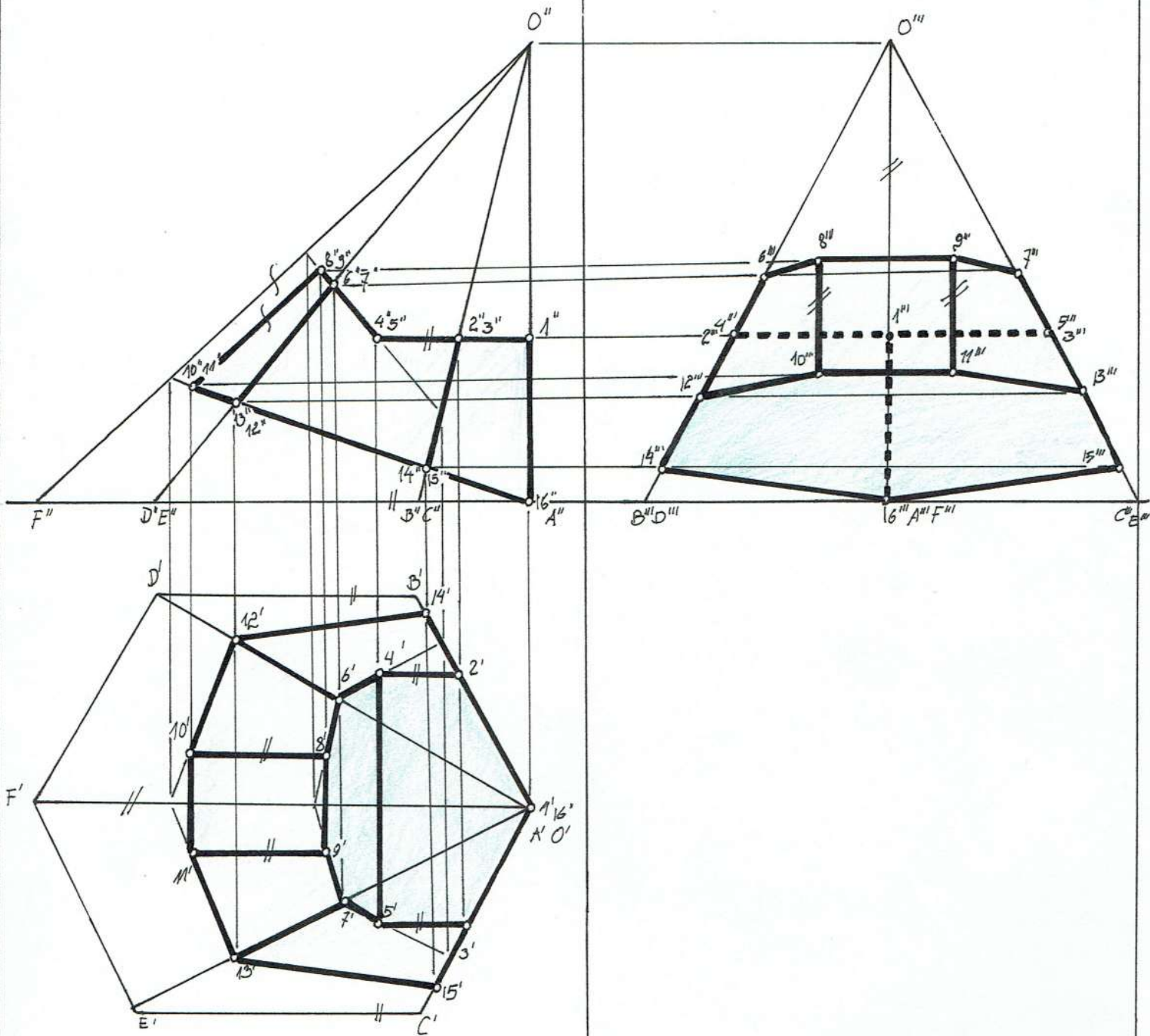

 - widoczne pozostałe ściany ostrosłupa

 - widoczne płaszczyzny wycięcia

Wyciół Architektury

Pol 1 Gr.3 R.S. 98/99

50my

Arkusz nr. 2.

